

PLATOS DE DUCHA
SHOWER TRAYS
RECEVEURS
DUSCHWANNEN
PIATTI DOCCIA

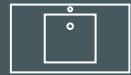

LAVABOS
WASHBASINS
LAVABOS
WASCHBECKEN
LAVABI



BAÑERAS
BATHTUBS
BAIGNOIRES
BADEWANNEN
VASCHE
pg. 32



MUEBLES
FURNITURE
MEUBLES
MÖBEL
MOBILI
pg. 34



INFORMACIÓN TÉCNICA
TECHNICAL INFORMATION
INFORMATION TECHNIQUE
TECHNISCHE INFORMATIONEN
INFORMAZIONI TECNICHE



pg. 50

Índice · Index

CÓDIGOS DE PLATOS

CODIGO FIJO	SERIE	COLOR	LARGO mm [L]	ANCHO mm [X]	CODIGO FIJO
01	--	--	----	----	M

SERIE

CO	COTTON SMOOTH NOX
CN	COTTON SMOOTH COVER
NO	NOVA STONE COVER
MI	* MIRAGE
ZE	ZEUS VULCANO
LI	LICEO VULCANO
CP	CENTURIA STONE NOX
CZ	CENTURIA SLATE NOX R1
CB	CENTURIA SLATE NOX R2
CL	CENTURIA SMOOTH
CC	CENTURIA COVER
D2	ANDROMEDA STONE NOX
DC	ANDROMEDA STONE COVER
LX	COLISEO STONE NOX
LC	COLISEO STONE COVER
AP	ARES STONE NOX
Q1	MALENQUE SQUARE COVER
Q2	MALENQUE SQUARE COVER
Q3	MALENQUE SQUARE NOX
Q4	MALENQUE SQUARE NOX
Q5	MALENQUE ANGULAR NOX
Q6	MALENQUE ANGULAR NOX
Q7	MALENQUE ANGULAR COVER

COLOR

BL	BLANCO
MR	MARFIL
BE	BEIGE
CA	CAPUCCINO
FA	FANGO
PE	GRIS PERLA
CE	CEMENTO
BA	BASALTO
AN	ANTRACITA
GR	GRAFITO
ES	RAL ESPECIAL

* COLOR MIRAGE

MC	CALACATTA
MM	MARQUINA
ME	BEIGE
MG	CAPUCCINO

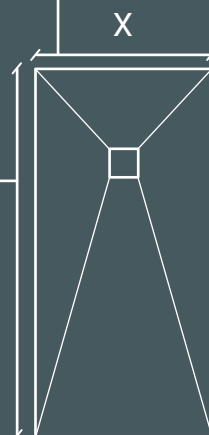

EXEMPLE

CODIGO FIJO	SERIE	COLOR	LARGO mm	ANCHO mm	CODIGO FIJO
01	CP	BL	1153	0872	M

01CPBL11530770M - CENTURIA STONE NOX BLANCO 115,3 x 77

CODIGOS DE ACCESORIOS

VÁLVULA GEBERIT 80 (ESTÁNDAR)	50VG
VÁLVULA VIEGA 60 HORIZONTAL	50V60
VÁLVULA VIEGA 80 HORIZONTAL	50VH001
VÁLVULA VIEGA 80 VERTICAL	50VV001
VÁLVULA VIEGA 50 HORIZONTAL	50VH002
VÁLVULA VIEGA 50 VERTICAL	50VV002

REJILLA INOX COLOR	REDONDA [R1]	CUADRADA [R2]
BL	01R1BLM	01R2BLM
MR	01R1MFM	01R2MFM
BE	01R1BEM	01R2BEM
CA	01R1CAM	01R2CAM
FA	01R1FAM	01R2FAM
PE	01R1PEM	01R2PEM
CE	01R1CEM	01R2CEM
BA	01R1BAM	01R2BAM
AN	01R1ANM	01R2ANM
GR	01R1GRM	01R2GRM

ACCESORIOS pg15
ACCESSORIES
ACCESSORIES
ZUBEHÖR
ACCESORIOS

NEW PANELES pg16
PANNEAUX
PANELS
TAFELN
PANNELLO

PANELES GRIFERIA pg17
PANNEAUX ROBINETTERIE
TAP PANELS
ARMATURAN TAFELN
PANNELLO RUBINETTO

PROLONCACIÓN pg17
PROLONGATION
EXTENSION
VERLÄNGERUNG
ESTENSIONE

MARCO pg17
CADRE
FRAME
RAHMEN
BORDO

ZOCALO DE ELEVACIÓN pg17
PLINTHE D'ELEVATION
ELEVATION PLINTH
ERHÖHTER SOCKEL
ELEVAZIONE ZOCCOLO

RAMPA pg17
RAMPE
RAMP
RAMPE
RAMPA



COTTON pg4



NOVA pg5



MIRAGE pg6



COLISEO pg7



ZEUS pg8



LICEO pg9



CENTURIA pg10



ANDROMEDA pg12



MALENKE pg13



ARES pg14

COTTON

NOX - COVER

CODIGO FIJO	SERIE	COLOR	LONG mm [L]	ANCHO mm [X]	CODIGO FIJO
01	--	--	----	----	M

L (CM)	NOX	COVER
	SMOOTH	SMOOTH

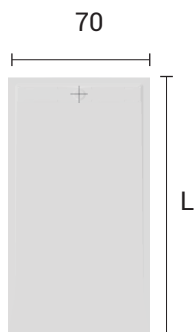

SERIE	CO	CN
100 - 120		447 €
121 - 140		482 €
151 - 160		539 €
161 - 180		605 €
191 - 210		698 €

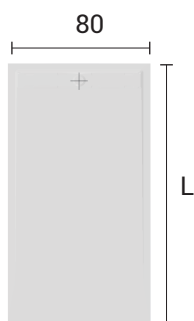

100 - 120	498 €
121 - 140	544 €
141 - 160	610 €
161 - 180	758 €
191 - 210	791 €

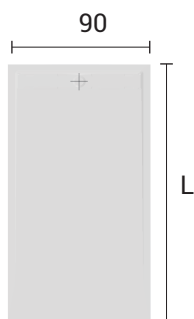

100 - 120	600 €
121 - 140	656 €
151 - 160	712 €
161 - 180	814 €
191 - 210	906 €

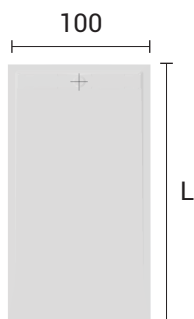

100 - 120	651 €
121 - 140	707 €
141 - 160	763 €
161 - 180	906 €
191 - 210	1.003 €

* SOLO COLOR BLANCO

CODIGO FIJO	SERIE	COLOR	LONG mm [L]	ANCHO mm [X]	CODIGO FIJO
01	--	--	----	----	M

NOVA

COVER

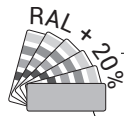

L (CM)	COVER
	STONE



81 - 90

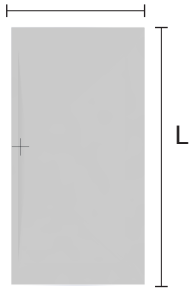

SERIE	NO
-------	----

100 - 120	543 €
121 - 140	626 €
141 - 160	706 €
161 - 180	789 €

91 - 100

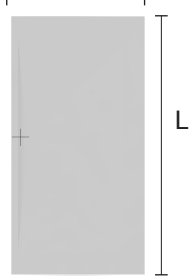

100 - 120	585 €
121 - 140	659 €
141 - 160	742 €
161 - 180	846 €

101 - 120

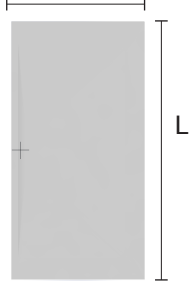

100 - 120	749 €
121 - 140	849 €
141 - 160	983 €
161 - 180	1.073 €

121 - 140

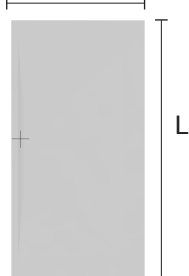

100 - 120	959 €
121 - 140	1.094 €
141 - 160	1.303 €
161 - 180	1.361 €

MIRAGE

DECORNOX

ACRY
PRINT

CODIGO FIJO	SERIE	COLOR	LONG mm [L]	ANCHO mm [X]	CODIGO FIJO
01	--	--	----	----	M

L (CM)	DECORNOX
	STONE



SERIE	MI
-------	----

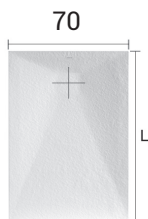

80 - 100	471 €
101 - 120	551 €
121 - 140	632 €
141 - 150	660 €
151 - 160	739 €
161 - 180	794 €

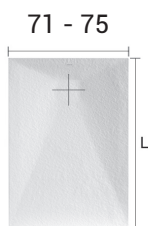

80 - 100	489 €
101 - 120	577 €
121 - 140	660 €
141 - 150	704 €
151 - 160	789 €
161 - 180	842 €

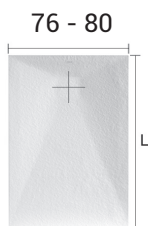

80 - 100	511 €
101 - 120	597 €
121 - 140	698 €
141 - 150	748 €
151 - 160	819 €
161 - 180	870 €

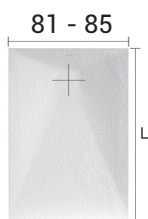

80 - 100	559 €
101 - 120	673 €
121 - 140	818 €
141 - 150	854 €
151 - 160	951 €
161 - 180	1.020 €



80 - 100	582 €
101 - 120	693 €
121 - 140	845 €
141 - 150	888 €
151 - 160	992 €
161 - 180	1.098 €



80 - 100	617 €
101 - 120	759 €
121 - 140	895 €
141 - 150	956 €
151 - 160	1.052 €
161 - 180	1.163 €

* Colores: M.CALACATTA / M.MARQUINA / M.BEIGE / M.GRIS

CODIGO FIJO	SERIE	COLOR	LONG mm [L]	ANCHO mm [X]	CODIGO FIJO
01	--	--	----	----	M



COLISEO

NOX - COVER

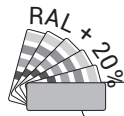

L (CM)

NOX STONE



75 - 80



SERIE	LX
100 - 120	364 €
121 - 140	426 €
141 - 150	457 €
151 - 160	508 €
161 - 180	520 €
181 - 190	560 €
191 - 200	623 €

OPCIÓN REJILLA LACADA



R2

Incremento de +10 €.

81 - 90



80 - 120	426 €
121 - 140	530 €
141 - 150	545 €
151 - 160	623 €
161 - 180	706 €
181 - 190	753 €
191 - 200	800 €

91 - 100



80 - 120	468 €
121 - 140	555 €
141 - 150	592 €
151 - 160	644 €
161 - 180	727 €
181 - 190	779 €
191 - 200	829 €

L (CM)

COVER STONE



105 - 120

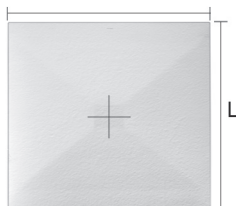

120 - 140	612 €
141 - 150	779 €
151 - 170	924 €

ZEUS

COVER

ACRY
SOFT



CODIGO FIJO	SERIE	COLOR	LONG mm [L]	ANCHO mm [X]	CODIGO FIJO
01	--	--	----	----	M

L (CM)	COVER
	VULCANO



SERIE	ZE
-------	----



100 - 120	513 €
121 - 140	575 €
141 - 150	788 €
151 - 160	668 €
161 - 180	696 €
181 - 190	736 €
191 - 210	790 €

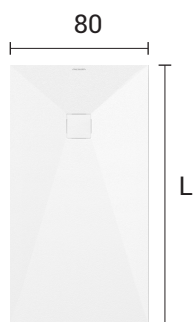

100 - 120	534 €
121 - 140	614 €
141 - 150	655 €
151 - 160	722 €
161 - 180	736 €
181 - 190	790 €
191 - 210	871 €

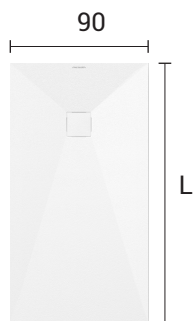

100 - 120	621 €
121 - 140	763 €
141 - 150	790 €
151 - 160	898 €
161 - 180	979 €
181 - 190	1.039 €
191 - 210	1.101 €



100 - 120	668 €
121 - 140	783 €
141 - 150	830 €
151 - 160	924 €
161 - 180	1.006 €
181 - 190	1.074 €
191 - 210	1.139 €

* COLOR: BLANCO / BEIGE / ANTRACITA / GRAFITO

CODIGO FIJO	SERIE	COLOR	LONG mm [L]	ANCHO mm [X]	CODIGO FIJO
01	--	--	----	----	M



ACRY
STONE

LICEO
COVER

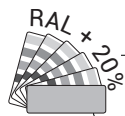

L (CM)

COVER

VULCANO



SERIE	LI
120	452 €
121 - 140	496 €
141 - 160	556 €
161 - 180	625 €
181 - 210	721 €



120	504 €
121 - 140	561 €
141 - 160	631 €
161 - 180	784 €
181 - 210	818 €



120	608 €
121 - 140	678 €
141 - 160	736 €
161 - 180	842 €
181 - 210	937 €



120	660 €
121 - 140	731 €
141 - 160	789 €
161 - 180	937 €
181 - 210	1.038 €

CENTURIA

ACRY
STONE

CODIGO FIJO	SERIE	COLOR	LONG mm [L]	ANCHO mm [X]	CODIGO FIJO
01	--	--	----	----	M

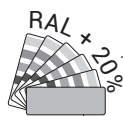

L (CM)	NOX	NOX	NOX	COVER	
	STONE	SLATE	SMOOTH	STONE	
SERIE :	CP	CZ / CB	CL **	CC	
70	80 - 100	302 €	302 €	302 €	347 €
	101 - 120	347 €	347 €	347 €	394 €
	121 - 140	394 €	394 €	394 €	441 €
	141 - 150	405 €	405 €	405 €	451 €
	151 - 160	468 €	468 €	468 €	514 €
	161 - 180	488 €	488 €	488 €	535 €
	181 - 190	520 €	520 €	520 €	566 €
	191 - 210	560 €	560 €	560 €	607 €

71 - 75	80 - 100	307 €	307 €	307 €	353 €
	101 - 120	359 €	359 €	359 €	405 €
	121 - 140	405 €	405 €	405 €	451 €
	141 - 150	431 €	431 €	431 €	478 €
	151 - 160	498 €	498 €	498 €	545 €
	161 - 180	514 €	514 €	514 €	560 €
	181 - 190	560 €	560 €	560 €	607 €
	191 - 210	612 €	612 €	612 €	659 €

76 - 80	80 - 100	317 €	317 €	317 €	364 €
	101 - 120	364 €	364 €	364 €	411 €
	121 - 140	426 €	426 €	426 €	473 €
	141 - 150	457 €	457 €	457 €	503 €
	151 - 160	508 €	508 €	508 €	555 €
	161 - 180	520 €	520 €	520 €	566 €
	181 - 190	567 €	567 €	567 €	613 €
	191 - 210	623 €	623 €	623 €	669 €

81 - 85	80 - 100	353 €	353 €	353 €	399 €
	101 - 120	426 €	426 €	426 €	473 €
	121 - 140	530 €	530 €	530 €	477 €
	141 - 150	545 €	545 €	545 €	592 €
	151 - 160	623 €	623 €	623 €	669 €
	161 - 180	649 €	649 €	649 €	696 €
	181 - 190	727 €	727 €	727 €	773 €
	191 - 210	753 €	753 €	753 €	800 €

** COLORES: BLANCS / BEIGE / CEMENTO / ANTRACITA

CODIGO FIJO	SERIE	COLOR	LONG mm [L]	ANCHO mm [X]	CODIGO FIJO
01	--	--	----	----	M



CENTURIA



L (CM)	NOX	NOX	NOX	COVER
	STONE	SLATE	SMOOTH	STONE
SERIE :	CP	CZ / CB	CL **	CC
86 - 90	364 €	364 €	364 €	411 €
101 - 120	431 €	431 €	431 €	478 €
121 - 140	540 €	540 €	540 €	587 €
141 - 150	560 €	560 €	560 €	607 €
151 - 160	644 €	644 €	644 €	691 €
161 - 180	706 €	706 €	706 €	753 €
181 - 190	753 €	753 €	753 €	800 €
191 - 210	800 €	800 €	800 €	846 €

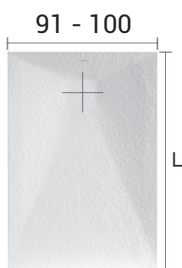
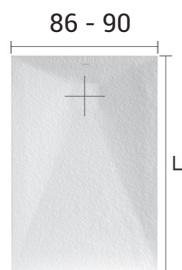

80 - 100	374 €	374 €	374 €	421 €
101 - 120	468 €	468 €	468 €	514 €
121 - 140	555 €	555 €	555 €	602 €
141 - 150	592 €	592 €	592 €	639 €
151 - 160	664 €	664 €	664 €	711 €
161 - 180	727 €	727 €	727 €	773 €
181 - 190	779 €	779 €	779 €	825 €
191 - 210	829 €	829 €	829 €	876 €

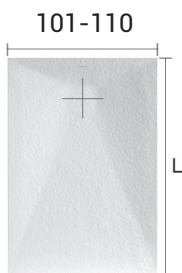

80 - 100	444 €
101 - 120	534 €
121 - 140	623 €
141 - 150	666 €
151 - 160	711 €
161 - 180	800 €
181 - 190	845 €
191 - 210	933 €

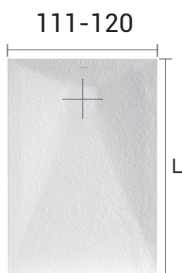

101 - 120	599 €
121 - 140	699 €
141 - 150	749 €
151 - 160	799 €
161 - 180	899 €

OPCIÓN REJILLA LACADA



R2



R1

Incremento de +10 €.

** COLORES: BLANC S/ BEIGE / CEMENTO / ANTRACITA

24h/48h salida de fábrica

CENTURIA STONE NOX	
Colores Blanco, Beige y Antracita	
70 x 100	302 €
70 x 120	347 €
70 x 140	394 €
70 x 150	405 €
70 x 160	468 €
70 x 170	488 €
80 x 100	317 €
80 x 120	364 €
80 x 140	426 €
80 x 150	457 €
80 x 160	508 €
80 x 170	520 €
80 x 180	520 €
90 x 90	364 €
90 x 100	364 €
90 x 120	431 €
90 x 140	540 €
90 x 150	560 €
90 x 160	644 €
90 x 180	706 €

* Para pedidos unitarios hasta acabar existencias.

ANDROMEDA

ACRY
STONE

NOX - COVER

CODIGO FIJO	SERIE	COLOR	LONG mm [L]	ANCHO mm [X]	CODIGO FIJO
01	--	--	----	----	M

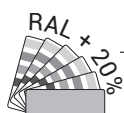

L (CM)	NOX STONE	COVER STONE
--------	--------------	----------------

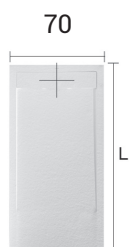
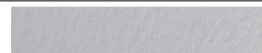

SERIE :	DP	DC
80 - 100	344 €	377 €
101 - 120	405 €	451 €
121 - 140	440 €	487 €
141 - 160	498 €	545 €
161 - 180	566 €	612 €
181 - 210	660 €	707 €

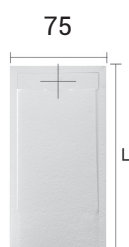

101 - 120	415 €	461 €
121 - 140	473 €	520 €
141 - 160	520 €	566 €
161 - 180	606 €	653 €
181 - 210	708 €	755 €

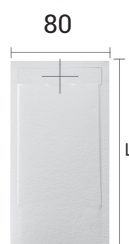

80 - 100	388 €	421 €
101 - 120	457 €	503 €
121 - 140	503 €	550 €
141 - 160	571 €	618 €
161 - 180	721 €	768 €
181 - 210	755 €	802 €

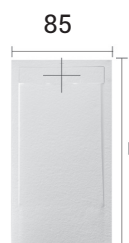

101 - 120	508 €	555 €
121 - 140	560 €	607 €
141 - 160	623 €	669 €
161 - 180	753 €	800 €
181 - 210	803 €	850 €



80 - 100	479 €	508 €
101 - 120	560 €	607 €
121 - 140	617 €	664 €
141 - 160	675 €	721 €
161 - 180	779 €	825 €
181 - 210	872 €	919 €



80 - 100	521 €	553 €
101 - 120	612 €	656 €
121 - 140	669 €	716 €
141 - 160	727 €	773 €
161 - 180	872 €	919 €
181 - 210	971 €	1.018 €

24h/48h salida de fábrica

ANDROMEDA STONE NOX Colores Blanco	
90 x 120	560 €
90 x 140	617 €
90 x 160	675 €

* Para pedidos unitarios hasta acabar existencias.

CODIGO FIJO	SERIE	COLOR	LONG mm [L]	ANCHO mm [X]	CODIGO FIJO
01	--	--	----	----	M



MALENKE

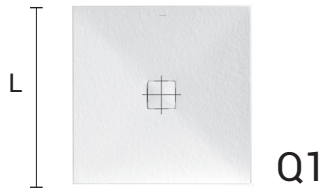
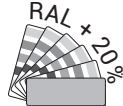

L (CM)	COVER STONE
--------	-------------

SERIE :	Q1
80 x 80	394 €
90 x 90	436 €
100 x 100	473 €

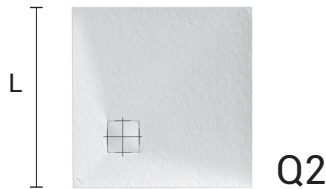

L (CM)	STONE
--------	-------

SERIE :	Q2
80 x 80	394 €
90 x 90	436 €
100 x 100	473 €

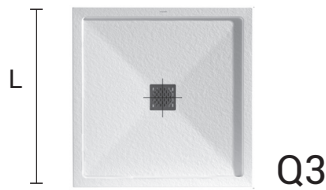

L (CM)	NOX STONE
--------	-----------

SERIE :	Q3
80 x 80	364 €
90 x 90	404 €
100 x 100	441 €

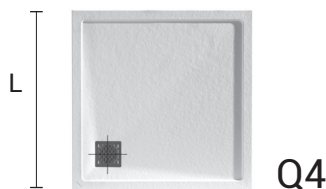

L (CM)	NOX STONE
--------	-----------

SERIE :	Q4
80 x 80	364 €
90 x 90	404 €
100 x 100	441 €

OPCIÓN REJILLA LACADA



R2

Incremento de +10 €.

MALENKE



CODIGO FIJO	SERIE	COLOR	LONG mm [L]	ANCHO mm [X]	CODIGO FIJO
01	--	--	----	----	M

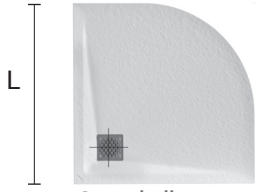
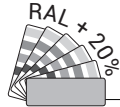

Q5

* Curva italiana

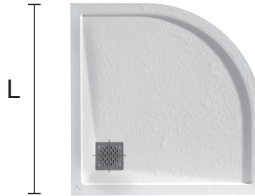

Q6

* Curva italiana

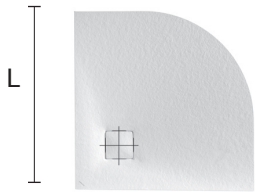

Q7

* Curva italiana

L (CM)

NOX STONE



SERIE :	Q5
80 x 80	317 €
90 x 90	353 €
100 x 100	389 €

SERIE :	Q6
80 x 80	364 €
90 x 90	399 €
100 x 100	431 €

L (CM)

COVER STONE



SERIE :	Q7
80 x 80	374 €
90 x 90	421 €
100 x 100	441 €

ARES

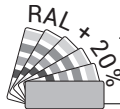

L (CM)

NOX STONE

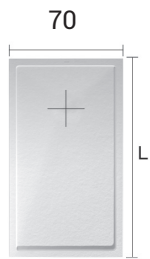

70

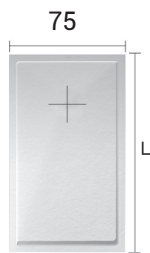

75

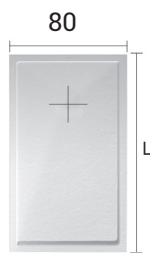

80

SERIE :	AP
100	322 €
120	353 €
140	384 €
160	436 €

100	332 €
120	374 €
140	411 €
160	514 €

100	342 €
120	394 €
140	468 €
160	520 €

OPCIÓN REJILLA LACADA



R2

Incremento de +10 €.

ACCESORIOS

DESCRIPCIÓN		REF.	P.V.P
KIT REPARACIÓN	adicional		52 €
KIT RECUPERACIÓN	adicional		72 €
KIT RECUPERACIÓN ZEUS	adicional		72 €
KIT REPARACION ACRYMOLD - SOLIDSURFACE	adicional		55 €
KIT LIMPIEZA - MANCHAS DIFÍCILES	adicional		43 €
VÁLVULAS PLATOS DE DUCHA			
VÁLVULA VIEGA 60 HORIZONTAL	adicional	50V60	63 €
VÁLVULA VIEGA 80 HORIZONTAL	adicional	50VH001	53 €
VÁLVULA VIEGA 80 VERTICAL	adicional	50VV001	68 €
VÁLVULA VIEGA 50 HORIZONTAL	adicional	50VH002	69 €
VÁLVULA VIEGA 50 VERTICAL	adicional	50VV002	78 €
VÁLVULA GEBERIT 60	adicional	50VG60	53 €
VÁLVULA GEBERIT 80	adicional	50VG	53 €
VÁLVULA MACALPINE 70	adicional	VM	53 €
VÁLVULA MACALPINE 50	adicional		60 €
VÁLVULA LAVABO			
VÁLVULA CLICK CLAK	adicional	50VALVCLIK	67 €
REJILLAS / TAPAS			
REJILLA INOX CUADRADA	adicional	01R2NXM	27 €
REJILLA INOX CUADRADA LACADA	adicional	01R2	37 €
REJILLA INOX REDONDA	adicional	01R1NXM	27 €
REJILLA INOX REDONDA LACADA	adicional	01R1	37 €
REJILLA ANDROMEDA NOX 70/75/80/85/90/100	adicional	50RD2	57 €
REJILLA INOX COTTON	adicional		47 €
TAPA COVER CENTURIA/COLISEO/MALEKE/ *ZEUS	adicional	01TC * 01TCZE	37 €
TAPA ANDROMEDA COVER 70/75/80/85/90/100	adicional	01TCDS	47 €
TAPA LICEO 70/80/90/100	adicional	01TCLI	47 €
TAPA NOVA	adicional		37 €
TAPA COTTON	adicional		47 €
EMBELLECEDOR ITACA / TEBAS	adicional	01LAVITACAEMB	37 €
COLORES RAL	adicional		+20 %

PANELES

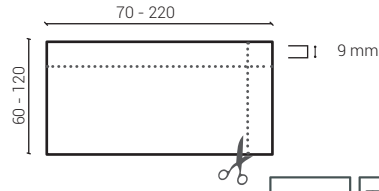
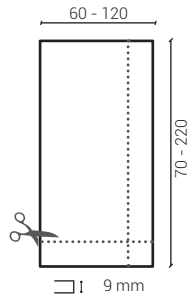

ACRY
STONE

0,9 cm.

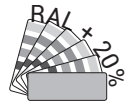

PANEL 09 STONE / SLATE / SMOOTH / VULCANO

H \ L	70-100	101-120	121-150	151-180	181-210	211-220
60	129 €	166 €	208 €	260 €	302 €	316 €
61-75	166 €	208 €	260 €	312 €	364 €	381 €
76-100	208 €	332 €	364 €	389 €	441 €	461 €
101-120	259 €	356 €	424 €	496 €	573 €	600 €

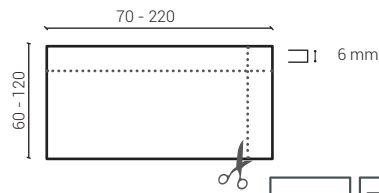
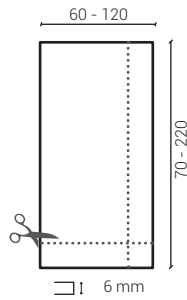

ACRY
STONE

0,6 cm.

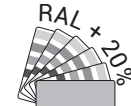

PANEL 06 STONE / SLATE / SMOOTH / VULCANO

H \ L	70-100	101-120	121-150	151-180	181-210	211-220
60	103 €	133 €	166 €	208 €	242 €	248 €
61-75	133 €	166 €	208 €	250 €	291 €	299 €
76-100	166 €	266 €	291 €	312 €	353 €	362 €
101-120	203 €	280 €	333 €	390 €	450 €	471 €

COLORES: BLANCO, MARFIL, BEIGE, CAPUCCINO, FANGO
GRIS PERLA, CEMENTO, BASALTO, ANTRACITA, GRAFITO

* Excepto por la textura SMOOTH: blanco, beige, cemento, antracita

PERFIL DE TRANSICIÓN



PERFIL
17 € / METRO LINEAL
* LONGITUD MAXI. 250CM

TRANSICIÓN

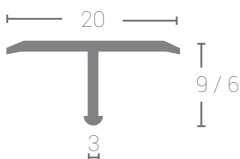

CANTO 09

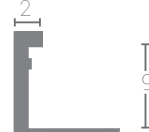

CANTO 06



PERFIL ÁNGULO





SIKAFLEX

SIKAFLEX

34 € / unidad

* COLORES: blanco, beige, cemento, negro

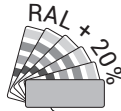
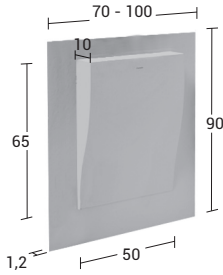

PANEL GRIFERIA

L (CM)

STONE

70 - 100

468 €

NO INCLUYE GRIFERÍA

INDICAR AGUJEROS PARA GRIFERÍA

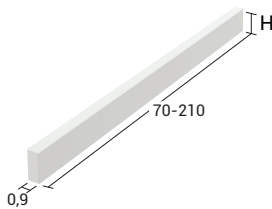

ZOCALO ELEVACION

H (CM)

STONE / SLATE / SMOOTH

4 - 9

0.52 € / CM LINEAL

10 - 15

0.77 € / CM LINEAL

16 - 20

1.04 € / CM LINEAL

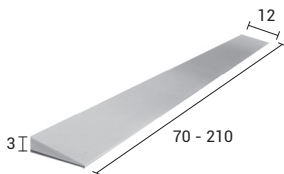

RAMPA

STONE

0.94 € / CM LINEAL



PROLONGACION

MEDIDAS (CM)

STONE

120 x 90 x 3

2.08 € / CM LINEAL

Para el cálculo del precio se tomará la dimensión mayor

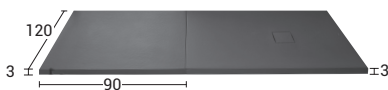

MARCO A MEDIDA STONE FRAMED

STONE

0.67 € / CM LINEAL

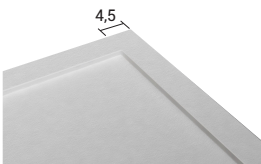

Índice · Index

LAVABOS

ENCIMERAS ESTANDAR

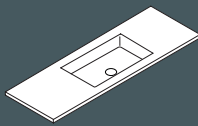

CORSO pg20

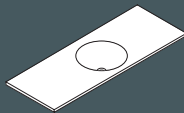

ASTRO pg20

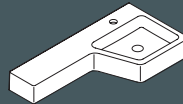

COLUMNA pg20



 OCEAN 80 pg21



 OCEAN 50 pg21

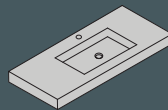

ULISES pg22

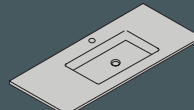

MINOS pg22

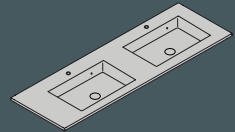

PERSEO pg22

ENCIMERAS PERSONALIZABLES

* FICHA DE PEDIDO PG 26-29

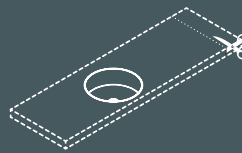

 PUZZLE pg24
ACRYMOLD
SOLID SURFACE

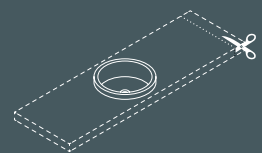

ACRYSTONE pg25

LAVABOS ESTANDAR



 WOK



DELIOS



NICEA

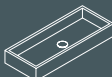

RODAS



EGEO

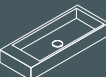

CALIPSO



ARGOS



TESEO



ITACA



TEBAS



ESS

ENCIMERAS ESTANDAR

CORSO

ACRY
MOLD



SIN AGUJERO PARA GRIFERÍA

61	394 €
81	434 €
101	845 €
121	556 €

* OPCIONAL AGUJERO PARA GRIFERIA



Válvula Click-Clack
Acrymold solid surface
opcional

67 €

ASTRO

ACRY
MOLD



SIN AGUJERO PARA GRIFERÍA (DCH / IZQ)

81	424 €
101	475 €
121	546 €

* OPCIONAL AGUJERO PARA GRIFERIA



Válvula Click-Clack
Acrymold solid surface
opcional

67 €

COLUMNA

ACRY
MOLD



SIN AGUJERO PARA GRIFERÍA

74,5 x 38x5 x 10	416 €
------------------	-------

* OPCIONAL AGUJERO PARA GRIFERIA



Válvula Click-Clack
Acrymold solid surface
opcional

67 €

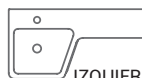

IZQUIERDA



DERECHA

BALDA

50 x 37	218 €
---------	-------

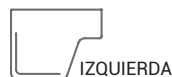

IZQUIERDA



DERECHA

ENCIMERAS ESTANDAR

OCEAN 50



SIN AGUJERO PARA GRIFERÍA (DCH / IZQ)

50 416 €

* OPCIONAL AGUJERO PARA GRIFERIA

OPCIONAL	P.V.P.
TOALLERO MECANIZADO	77 €
SOPERTE METÁLICO 2 UND	77 €
VÁLVULA Click-Clack blanca	67 €

BALDA 50 155 €



SIN AGUJERO PARA GRIFERÍA (DCH / IZQ)

50 525 €

* OPCIONAL AGUJERO PARA GRIFERIA

OPCIONAL	P.V.P.
TOALLERO MECANIZADO	77 €
SOPERTE METÁLICO 2 UND	77 €
VÁLVULA Click-Clack blanca	67 €

BALDA ACRYPRINT 50 217 €

OCEAN 80



SIN AGUJERO PARA GRIFERÍA (DCH / IZQ)

80 516 €

* OPCIONAL AGUJERO PARA GRIFERIA

OPCIONAL	P.V.P.
TOALLERO MECANIZADO	77 €
SOPERTE METÁLICO 2 UND	77 €
VÁLVULA Click-Clack blanca	67 €

BALDA 80 247 €



SIN AGUJERO PARA GRIFERÍA (DCH / IZQ)

80 625 €

* OPCIONAL AGUJERO PARA GRIFERIA

OPCIONAL	P.V.P.
TOALLERO MECANIZADO	77 €
SOPERTE METÁLICO 2 UND	77 €
VÁLVULA Click-Clack blanca	67 €

BALDA ACRYPRINT 80 356 €

ULISES

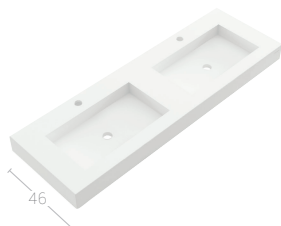
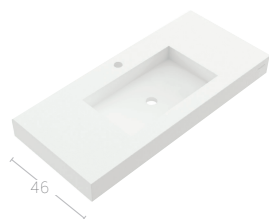
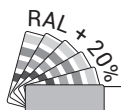

MEDIDAS (CM)

STONE

INCLUYE SOPORTE METÁLICO / CON AGUJERO PARA GRIFERÍA

70 441 €

80 508 €

100 612 €

120 706 €

INCLUYE SOPORTE METÁLICO / CON AGUJERO PARA GRIFERÍA

140 725 €

OPCIONAL

P.V.P.

TOALLERO MECANIZADO

77 €

* OPCIONAL SIN AGUJERO PARA GRIFERIA

MINOS



CON AGUJERO PARA GRIFERÍA

61 302 €

71 337 €

81 364 €

91 379 €

101 394 €

111 415 €

121 468 €

* OPCIONAL SIN AGUJERO PARA GRIFERIA

PERSEO

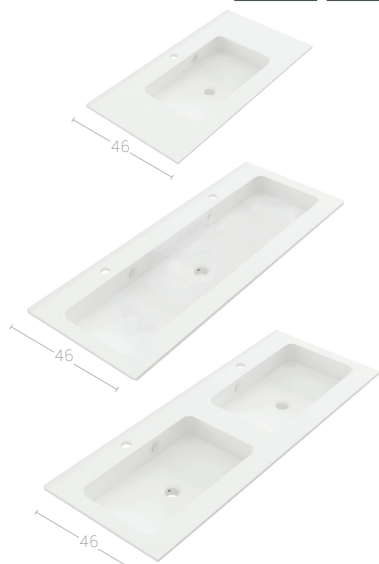

CON AGUJERO PARA GRIFERÍA

60 364 €

80 389 €

120 - SENO XL 473 €

CON AGUJERO PARA GRIFERÍA

120 DOBLE SENO 493 €

* OPCIONAL SIN AGUJERO PARA GRIFERIA

ENCIMERAS PERSONALIZABLES



Ejemplo

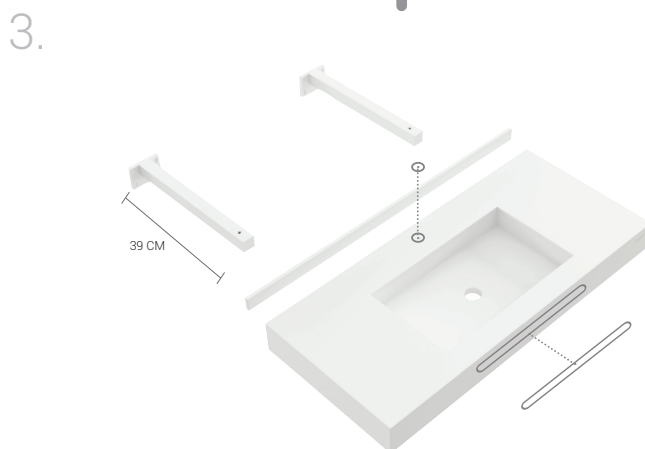
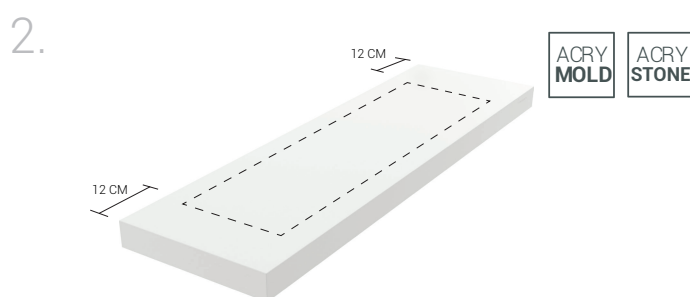

REFERENCIA	UDS	PVP
LAV.Y03	1	302 €
ENCIMERA ref.I 100 X 52 CM	1	100 x 3,7 = 350 €
TOALLERO MECANIZADO	1	77 €
SOPORTE SUJECIÓN 2 unidades	1	77 €
AGUJERO PARA GRIFERÍA	1	-
ZÓCALO PERIMETRAL 100 X 4 X 1.2 CM	1	100 X 0,77 = 77 €

883 €

* ES NECESARIO ADJUNTAR UN PLANO ACOTADO CON EL PEDIDO

* FICHA DE PEDIDO PG 26 / 27 / 28 / 29

ENCIMERAS PERSONALIZABLES

ACRY
MOLD

PUZZLE ACRYMOLD® SOLID SURFACE

1. Seleccionar lavabo



Y01

302 €



Y02

302 €

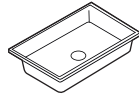

Y03

302 €

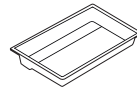

Y04

364 €

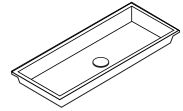

Y05

364 €



Y06

270 €



Y07

343 €

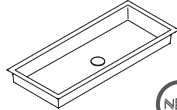

Y08

475 €



NEW



Y09

290 €



NEW



Y10

367 €



NEW

2. Seleccionar encimera y medidas

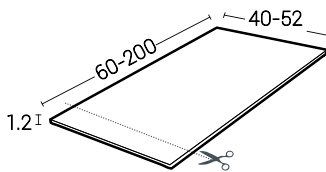

REF. R

2,8 € / CM LINEAL

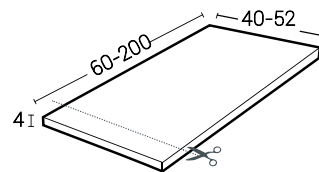

REF. E

3,7 € / CM LINEAL

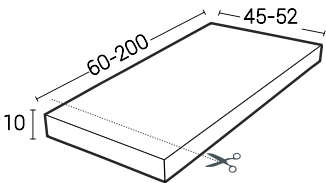

REF. I

3,7 € / CM LINEAL

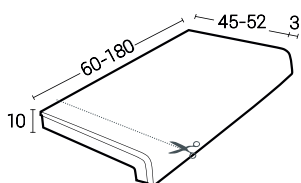

REF. C

3,7 € / CM LINEAL

3. Seleccionar complementos

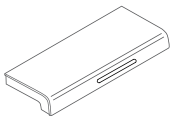

ref. C

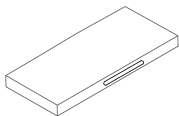

ref. I

TOALLERO MECANIZADO (Sólo ref. I - ref. C)

77 €

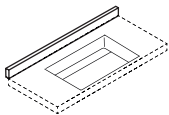

ZÓCALO PERIMETRAL 4 X 1,2 CM

0,77 € / CM LINEAL

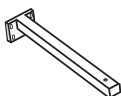

SOPORTE SUJECIÓN 2 unidades (ancho 60 - 120 cm)

77 €

SOPORTE SUJECIÓN 3 unidades (para doble seno)

118 €

SOPORTE SUJECIÓN 4 unidades (ancho 121 - 200 cm)

154 €



OPCIONAL - válvula de click clack

77 €

ENCIMERAS PERSONALIZABLES



1. Seleccionar lavabo ACRYMOLD® SOLID SURFACE

CRETA 302 €	ENEa 343 €	WOK 270 €	WOK 351 €	WOK 400 €
DELIOS 397 €	NICEa 352 €	RODAS 423 €	EGEO 376 €	CALIPSO 447 €

BLANCO BL/GRAFITO

BL/M.CALACATTA
BL/M.MARQUINA
BL/M.GRIS
BL/M.BEIGE

2. Seleccionar encimera y medidas ACRYSTONE

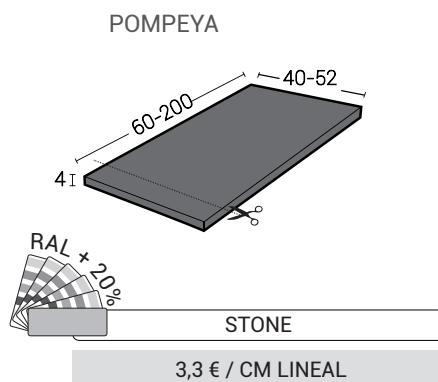
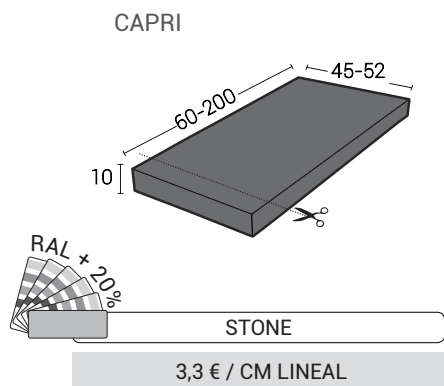

3. Seleccionar complementos

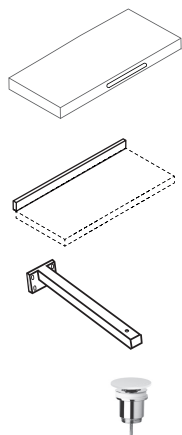

TOALLERO MECANIZADO (Sólo Capri)

77 €

ZÓCALO PERIMETRAL 4 X 1,2 CM

0,77 € / CM LINEAL

SOPORTE SUJECIÓN 2 unidades (ancho 60 - 120 cm)

77 €

SOPORTE SUJECIÓN 3 unidades (para doble seno)

118 €

SOPORTE SUJECIÓN 4 unidades (ancho 121 - 200 cm)

154 €

OPCIONAL - válvula de click clack

67 €

CORTE POR AGUJERO PARA LAVABO
(si el modelo no es MCBATH)

77 €

FICHA TÉCNICA DE PEDIDO_LINEA

PUZZLE ACRYMOLD® SOLID SURFACE

CLIENTE FECHA
ORDEN LINEA

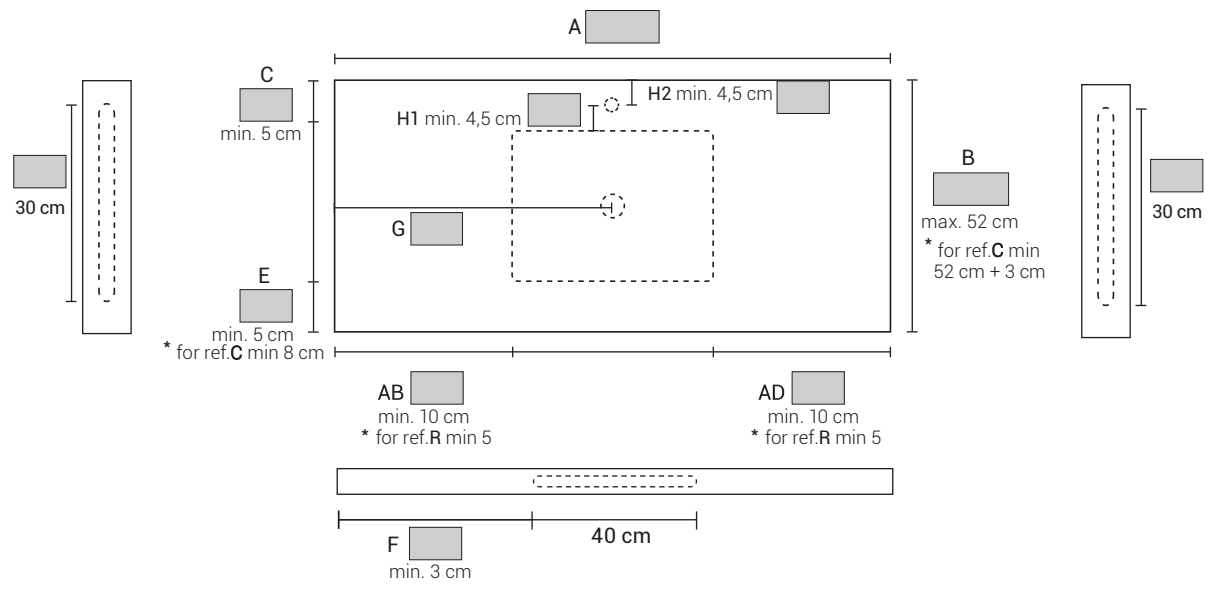
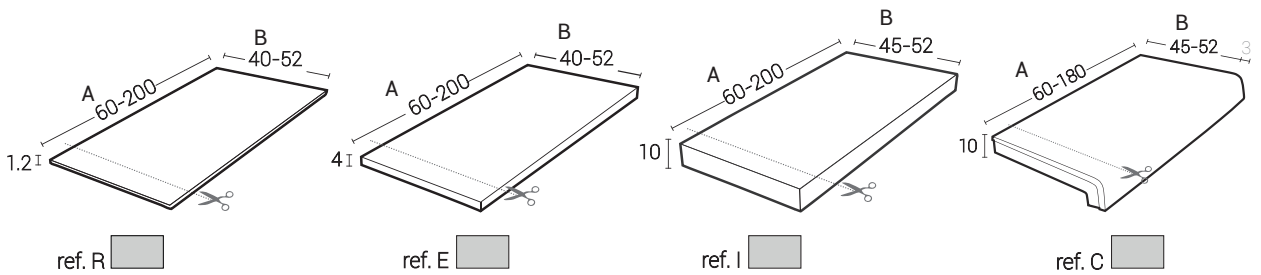
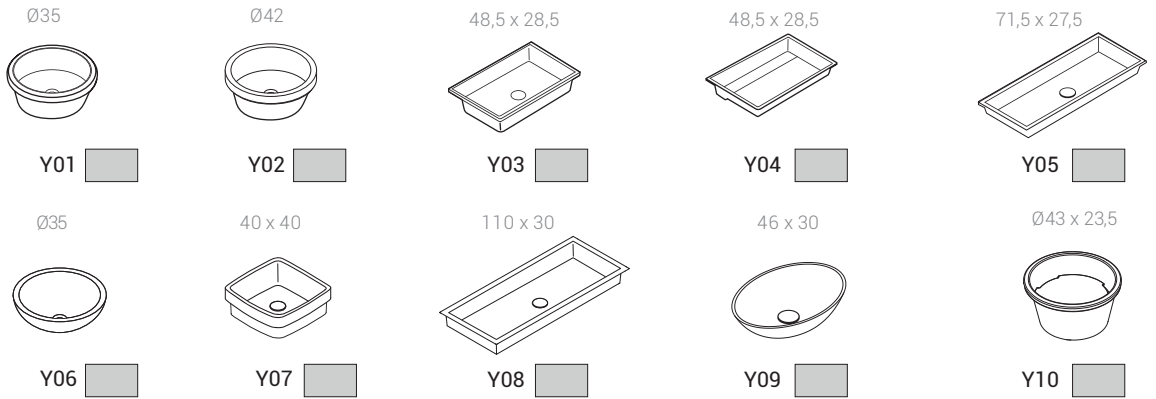

FICHA TÉCNICA DE PEDIDO_LINEA

CLIENTE FECHA
 ORDEN LINEA

PUZZLE ACRYMOLD® SOLID SURFACE

Ø35



Y01

Ø42



Y02

48,5 x 28,5

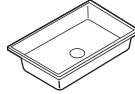

Y03

48,5 x 28,5

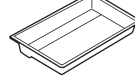

Y04

71,5 x 27,5

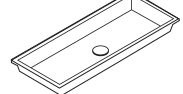

Y05

Ø35



Y06

40 x 40



Y07

110 x 30

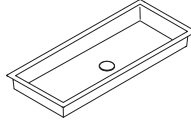

Y08

46 x 30



Y09

Ø43 x 23,5



Y10

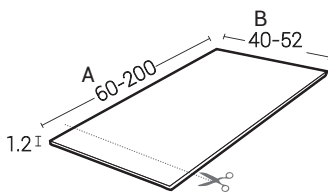

ref. R

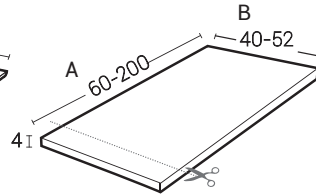

ref. E

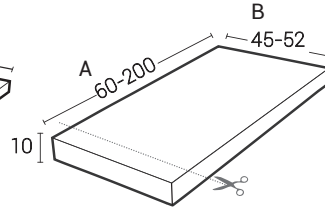

ref. I

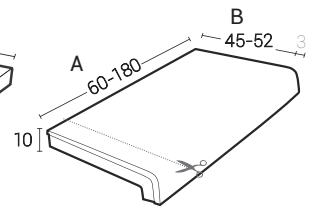

ref. C

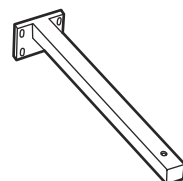
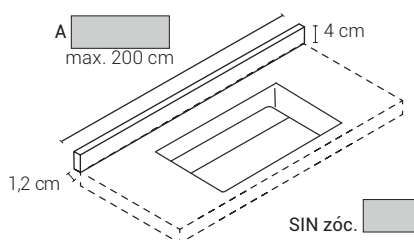
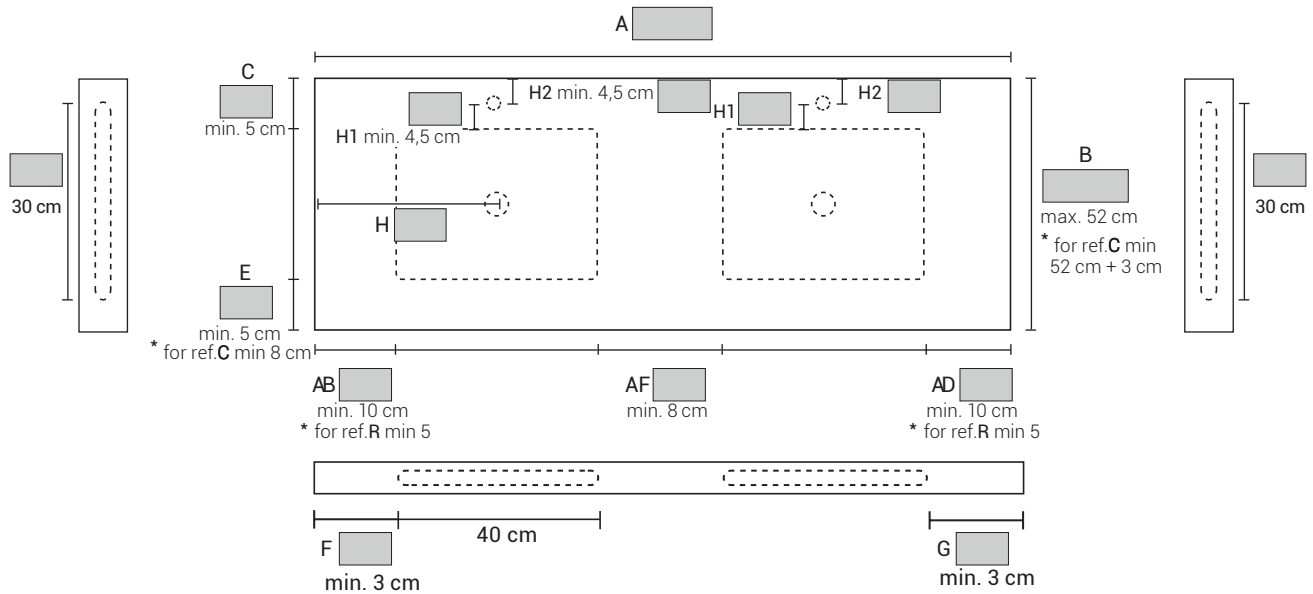

- 2 uds
- 3 uds
- 4 uds
- SIN sop.

FICHA TÉCNICA DE PEDIDO_LINEA

PUZZLE ACRYSTONE®

CLIENTE FECHA
 ORDEN LINEA

ACRY MOLD

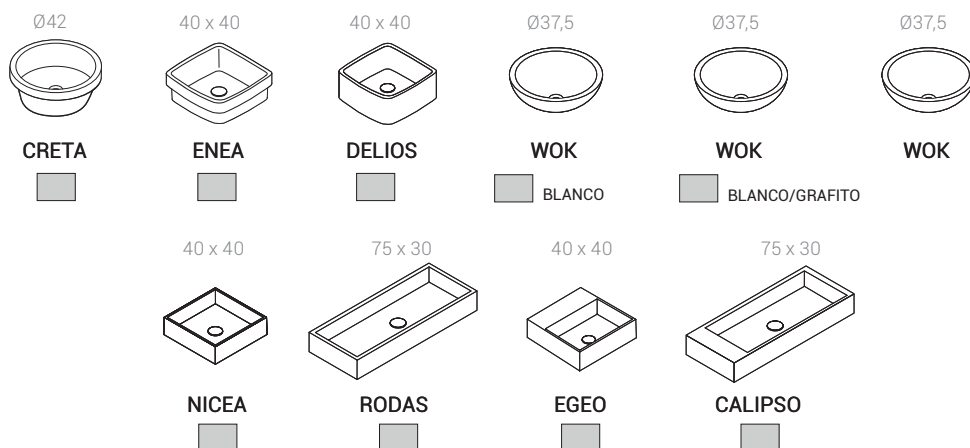

ACRY PRINT

- BL/M.CALACATTA
- BL/M.MARQUINA
- BL/M.BEIGE
- BL/M.GRIS

ACRY STONE

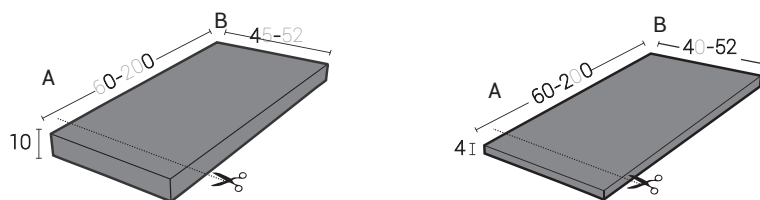

CAPRI

POMPEYA

COLOR

- BLANCO
- MARFIL
- BEIGE
- CAPUCCINO
- FANGO
- GRIS PERLA
- CEMENTO
- BASALTO
- ANTRACITA
- GRAFITO
- RAL

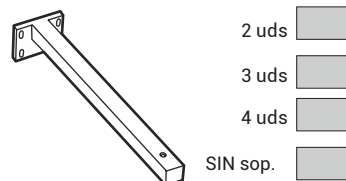
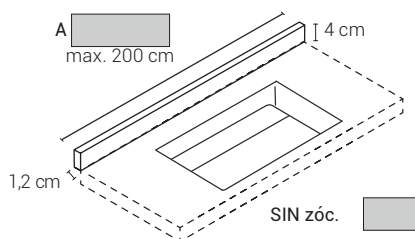
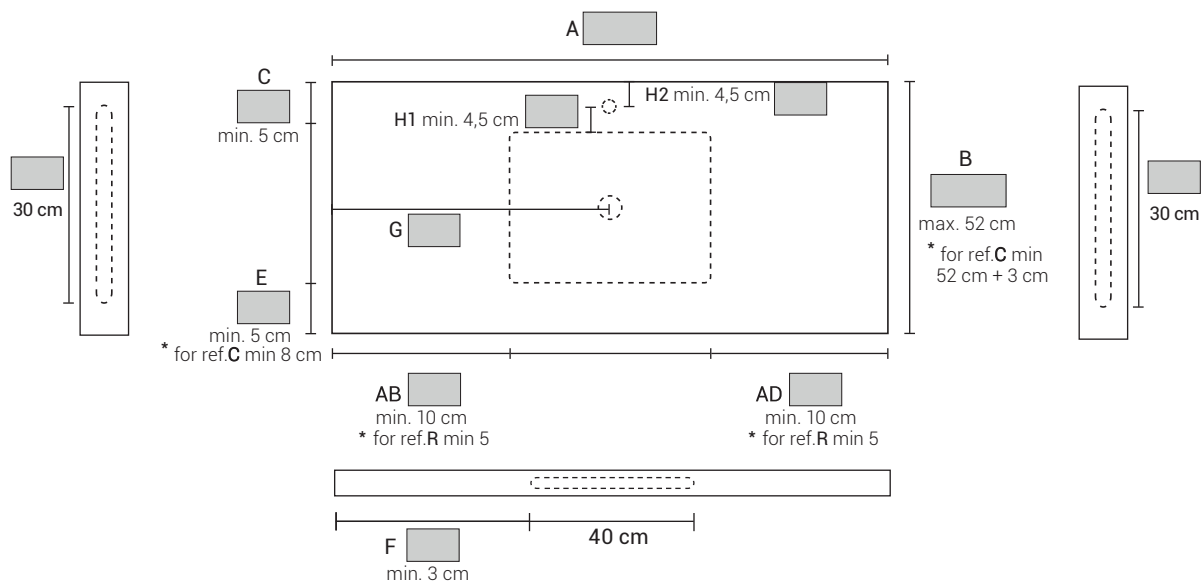

FICHA TÉCNICA DE PEDIDO_LINEA

CLIENTE FECHA
 ORDEN LINEA

PUZZLE ACRYSTONE®

ACRY
MOLD



CRETA

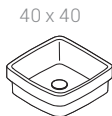

ENEA

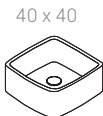

DELIOS



WOK



WOK



WOK

ACRY
PRINT

- BL/M.CALACATTA
- BL/M.MARQUINA
- BL/M.BEIGE
- BL/M.GRIS

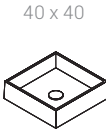

NICEA

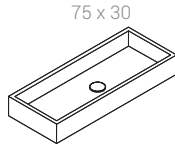

RODAS

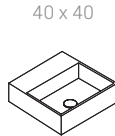

EGEO

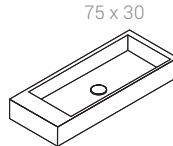

CALIPSO



ACRY
STONE

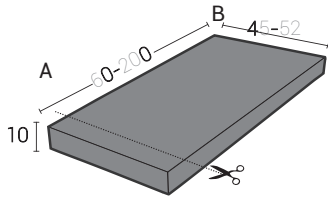

CAPRI

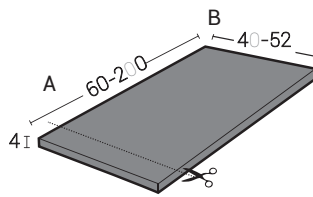

POMPEYA

COLOR

- BLANCO
- MARFIL
- BEIGE
- CAPUCCINO
- FANGO
- GRIS PERLA
- CEMENTO
- BASALTO
- ANTRACITA
- GRAFITO
- RAL

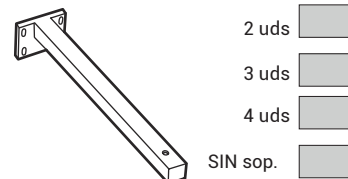
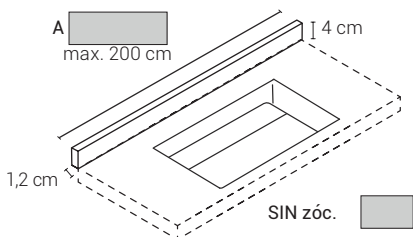
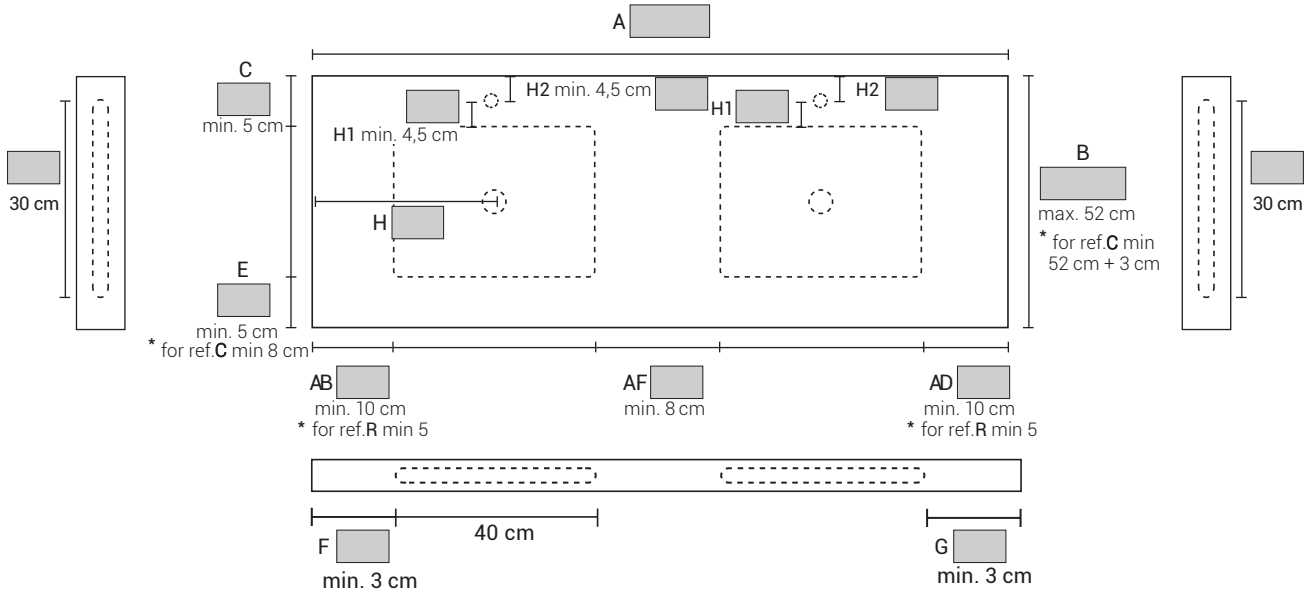

LAVABOS ESTANDAR



ACRYMOLD
SOLID SURFACE



WOK	WOK	WOK
270 €	351 €	400 €
BLANCO	BL/GRAFITO	BL/CALACATTA BL/MARQUINA BL/TRAVERTINO GRIS BL/TRAVERTINO BEIGE



DELIOS	NICEA	RODAS
397 €	352 €	423 €

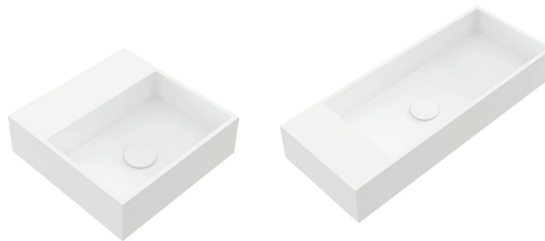

EGEO	CALIPSO
376 €	447 €



* AGUJERO PARA GRIFO OPCIONAL * AGUJERO PARA GRIFO OPCIONAL

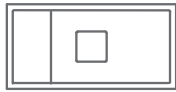

IZQ

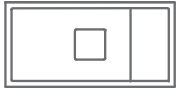

DCH



ARGOS (Fijaciones incluidas)

294 €

* AGUJERO PARA GRIFO OPCIONAL



TESEO (Fijaciones incluidas)

391 €

* AGUJERO PARA GRIFO OPCIONAL



TEBAS (Fijaciones incluidas)

1.563 €

* AGUJERO PARA GRIFO OPCIONAL



ESS (Fijaciones incluidas)

866 €

* AGUJERO PARA GRIFO OPCIONAL



ITACA (Fijaciones incluidas)

632 €

* AGUJERO PARA GRIFO OPCIONAL



Válvula Click-Clack
Acrymold solid surface
opcional

67 €

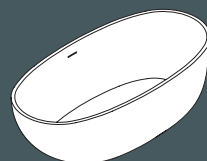

OVAL pg28

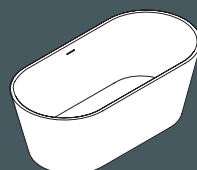

BLOCK pg29

BAÑERAS

ACRYMOLD®
SOLID SURFACE



OVAL

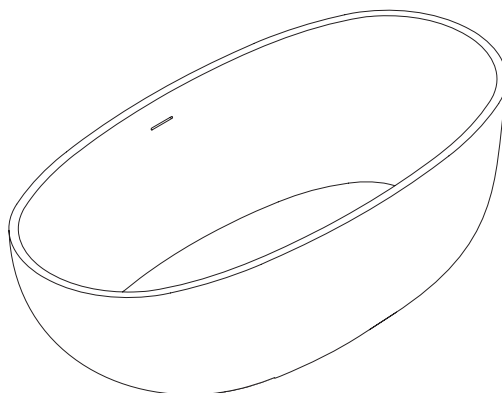

OVAL BLANCA

3.006 €

* Válvula y sifón incluidos



OVAL BLANCA/GRAFITO

3.606 €

* Válvula y sifón incluidos

BLOCK

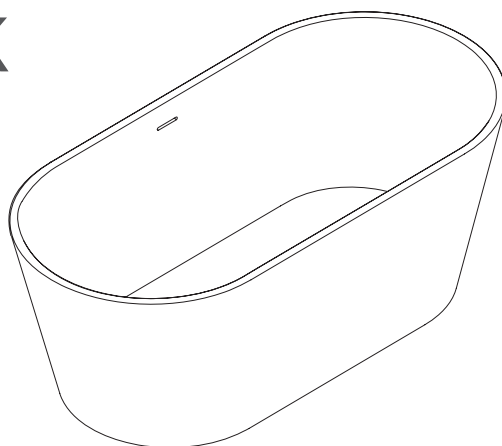

BLOCK BLANCA

3.051 €

* Válvula y sifón incluidos



BLOCK BLANCA/GRAFITO

3.651 €

* Válvula y sifón incluidos





BALTIC pg40



SCALA pg32



AIRE pg36

BALTIC



LAVABO ACRYMOLD®
MUEBLE ROBLE MACIZO

80 x 48 x 90

646 €



LAVABO ACRYMOLD®
MUEBLE ROBLE MACIZO

80 x 48 x 21,5

487 €



ESTANTERÍA
ROBLE MACIZO

60 x 32 x 160

503 €

SCALA



ACRYMOLD®
SOLID SURFACE

1. Seleccionar lavabo



Y01
302 €



Y02
302 €

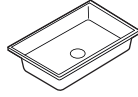

Y03
302 €

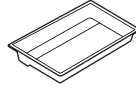

Y04
364 €

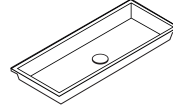

Y05
364 €

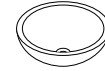

Y06
270 €



Y07
343 €

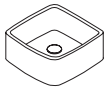

DELIOS
397 €

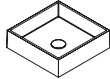

NICEA
352 €



WOK
270 €
BLANCO



WOK
351 €
BL/GRAFITO



WOK
400 €
BL/M.CALACATTA
BL/M.MARQUINA
BL/M.GRIS
BL/M.BEIGE

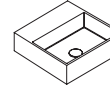

EGEO
376 €

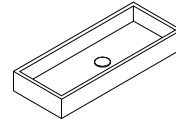

RODAS
423 €

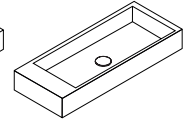

CALIPSO
447 €



2. Seleccionar encimera y medidas

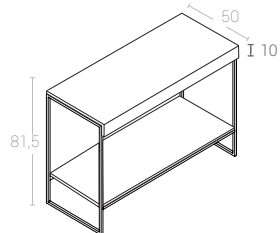
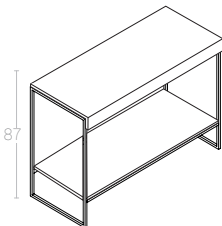
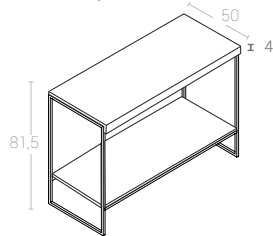
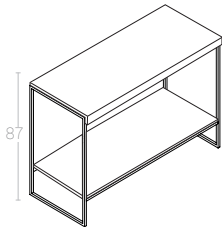
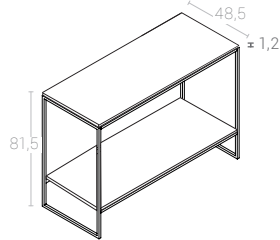
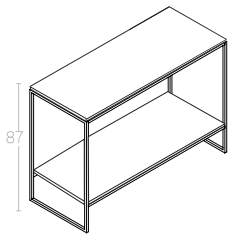

* Altura del mueble para lavabo de encastre o semiencastre

ENCIMERA SUPERIOR REF. SR

medidas	altura 87 cm	altura 81,5 cm
80 cm	746 €	736 €
100 cm	828 €	818 €
120 cm	913 €	903 €

ENCIMERA SUPERIOR REF. SE

medidas	altura 87 cm	altura 81,5 cm
80 cm	756 €	746 €
100 cm	839 €	828 €
120 cm	923 €	913 €

ENCIMERA SUPERIOR REF. SI

medidas	altura 87 cm	altura 81,5 cm
80 cm	766 €	756 €
100 cm	849 €	839 €
120 cm	933 €	923 €

Estructura de metal acabado negro mate / balda inferior incluida.

3. Seleccionar complementos

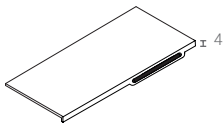

TOALLERO MECANIZADO REF. SI 77€

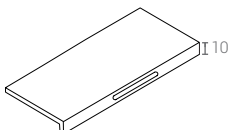

TOALLERO MECANIZADO REF. SI 77 €

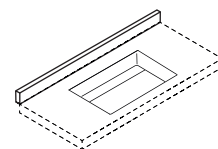

ZÓCALO









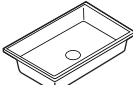
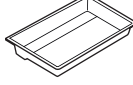
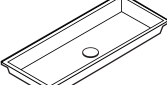

0.77 € / CM LINEAL

FICHA TÉCNICA DE PEDIDO

CLIENTE

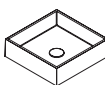
FECHA

ACRYMOLD®
SOLID SURFACE

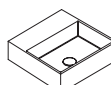
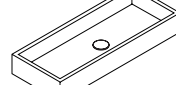
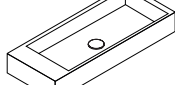
Ø35  Y01 <input type="checkbox"/>	Ø42  Y02 <input type="checkbox"/>	48,5 x 28,5  Y03 <input type="checkbox"/>	48,5 x 28,5  Y04 <input type="checkbox"/>	71,5 x 27,5  Y05 <input type="checkbox"/>	Ø35  Y06 <input type="checkbox"/>	40 x 40  Y07 <input type="checkbox"/>	
40 x 40  DELIOS <input type="checkbox"/>	40 x 40  NICEA <input type="checkbox"/>	Ø37,5  WOK <input type="checkbox"/> BLANCO	Ø37,5  WOK <input type="checkbox"/> BL/GRAFITO	Ø37,5  WOK <input type="checkbox"/> BL/M.CALACATTA <input type="checkbox"/> BL/M.MARQUINA <input type="checkbox"/> BL/M.GRIS <input type="checkbox"/> BL/M.BEIGE	40 x 40  EGEO <input type="checkbox"/>	75 x 30  RODAS <input type="checkbox"/>	75 x 30  CALIPSO <input type="checkbox"/>

ENCIMERA REF. SR

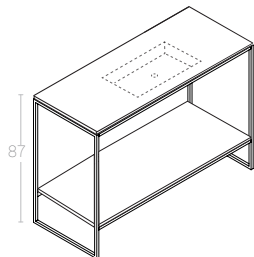

80 100 120

ENCIMERA REF. SR

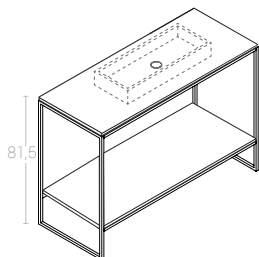

80 100 120

ENCIMERA REF. SE

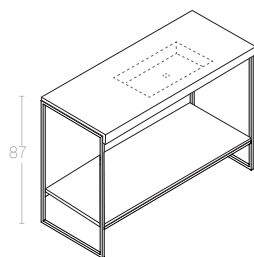

80 100 120

ENCIMERA REF. SE

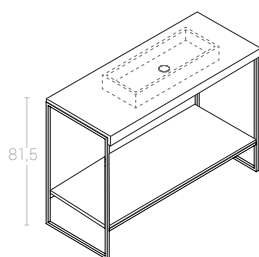

80 100 120

ENCIMERA REF. SI

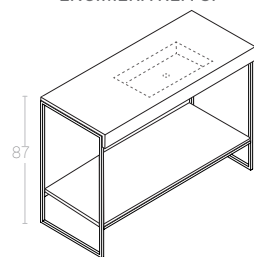

80 100 120

ENCIMERA REF. SI

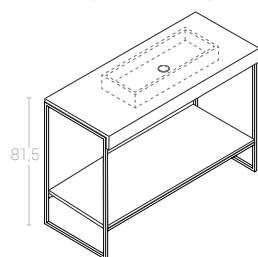

80 100 120

POSICION TOALLERO

REF. SI

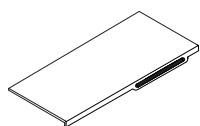

cent
dch
izq
doble

SIN toallero

REF. SI

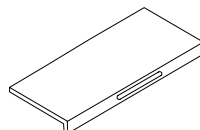

cent
dch
izq
doble

SIN toallero

POSICION LAVABO

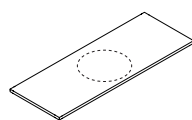

cent

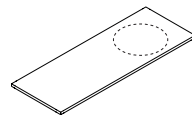

dch

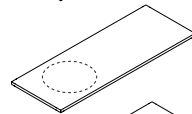

izq

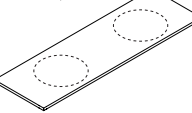

2 SENOS

excepto: Y05, Rodas, Calipso

POSICION AGUJERO GRIFO

izq cent dch sin

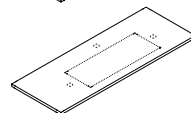
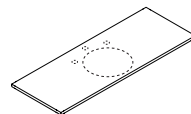

ZOCALO

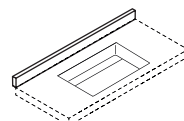

SI
NO

SCALA



ACRYSTONE®

1. Seleccionar lavabo ACRYMOLD® SOLID SURFACE



CRETA
302 €



ENEJA
343 €

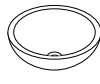

WOK
270 €

BLANCO



WOK
351 €

BL/GRAFITO



NEW

WOK
400 €

BL/M.CALACATTA
BL/M.MARQUINA
BL/M.GRIS
BL/M.BEIGE

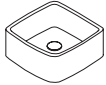

DELIOS
397 €

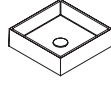

NICEA
352 €

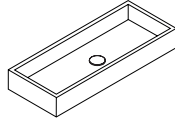

RODAS
447 €

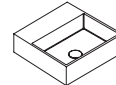

EGEO
376 €

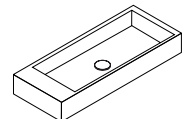

CALIPSO
447 €

2. Seleccionar encimera y medidas ACRYSTONE®

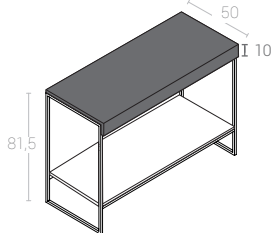
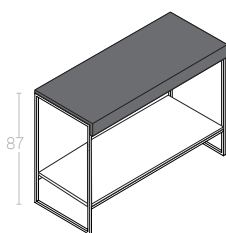
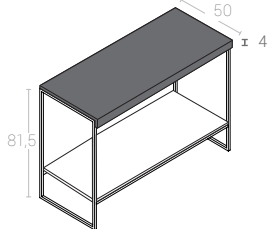
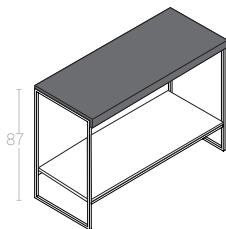
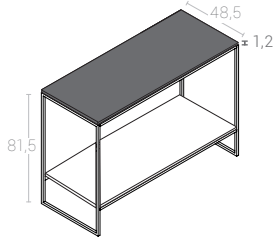
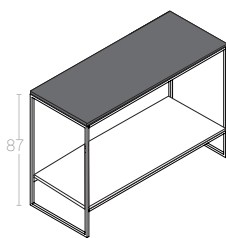

ENCIMERA SUPERIOR REF. PS

medidas	altura 87 cm	altura 81,5 cm
80 cm	680 €	669 €
100 cm	745 €	735 €
120 cm	801 €	791 €

ENCIMERA SUPERIOR REF. PE

medidas	altura 87 cm	altura 81,5 cm
80 cm	690 €	680 €
100 cm	755 €	745 €
120 cm	811 €	801 €

ENCIMERA SUPERIOR REF. CI

medidas	altura 87 cm	altura 81,5 cm
80 cm	700 €	690 €
100 cm	765 €	755 €
120 cm	821 €	811 €

Estructura de metal acabado negro mate / balda inferior incluida.

* Altura del mueble para lavabo de encastre o semiencastre

3. Seleccionar complementos

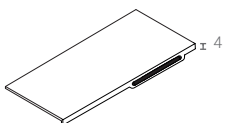

TOALLERO MECANIZADO REF. CI.1 77 €

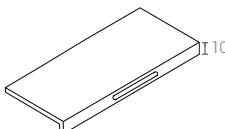

TOALLERO MECANIZADO REF. CI.2 77 €

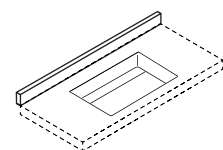

ZÓCALO
0.77 € / CM LINEAL

FICHA TÉCNICA DE PEDIDO

ACRYSTONE®

CLIENTE.....

FECHA.....



Y06

Y07

WOK

WOK

WOK



BLANCO

BLANCO/GRAFITO

BLANCO/M.CALACATTA

BLANCO/M.MARQUINA

BLANCO/M.GRIS

BLANCO/M.BEIGE

ACRY
PRINT

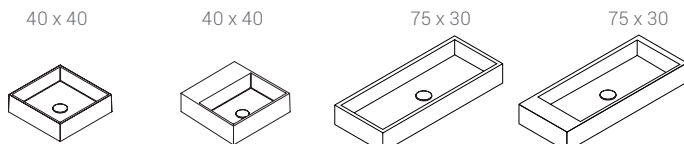

NICEA

EGEO

RODAS

CALIPSO



ACRY
MOLD

ENCIMERA REF. PS

ENCIMERA REF. PE

ENCIMERA REF. CI

ACRY
STONE

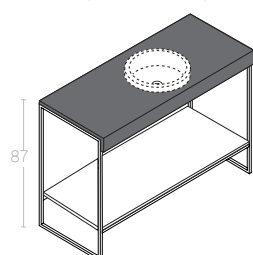
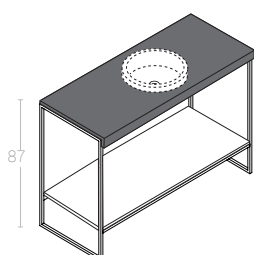
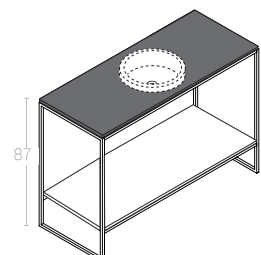

80 100 120

80 100 120

80 100 120

COLOR

- BLANCO
- MARFIL
- BEIGE
- CAPUCCINO
- FANGO
- GRIS PERLA
- CEMENTO
- BASALTO
- ANTRACITA
- GRAFITO
- RAL

ENCIMERA REF. PS

ENCIMERA REF. PE

ENCIMERA REF. CI

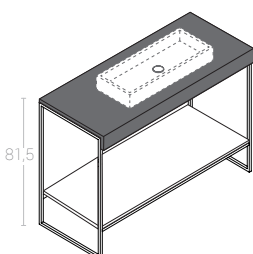
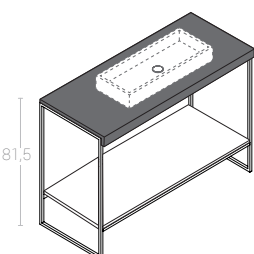
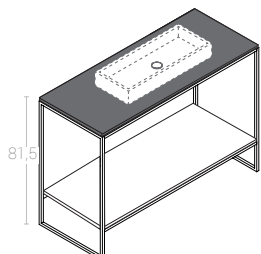

80 100 120

80 100 120

80 100 120

POSICION TOALLERO

POSICION LAVABO

POSICION AGUJERO GRIFO

REF. CI.1

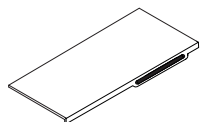

- cent
- dch
- izq
- doble

SIN toallero

REF.CI.2

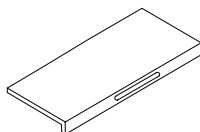

- cent
- dch
- izq
- doble

SIN toallero

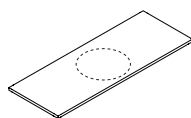

cent

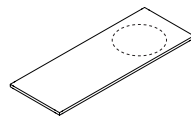

dch

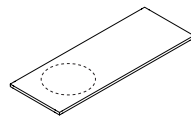

izq

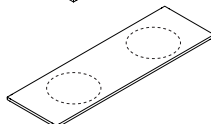

2 SENOS

excepto: Rodas, Calipso

- izq
- cent
- dch
- sin

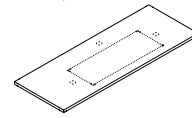
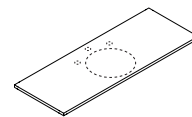

ZOCALO

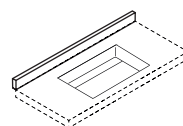

SI

NO

SCALA



ACRYPRINT®

1. Seleccionar lavabo ACRYMOLD® SOLID SURFACE



CRETA
302 €

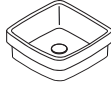

ENEА
343 €

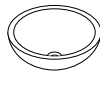

WOK
270 €

BLANCO



WOK
351 €

BL/GRAFITO

NEW



WOK
400 €

BL/M.CALACATTA
BL/M.MARQUINA
BL/M.GRIS
BL/M.BEIGE



DELIOS
397 €

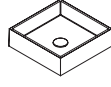

NICEА
352 €

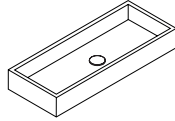

RODAS
447 €

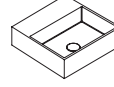

EGEO
376 €

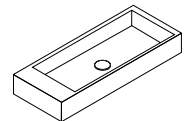

CALIPSO
447 €

2. Seleccionar encimera y medidas ACRYSTONE®

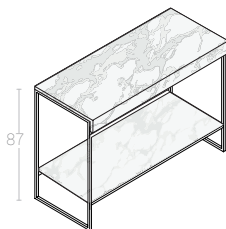
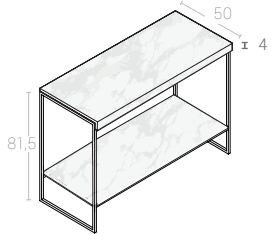
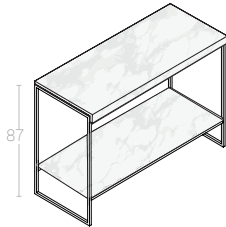
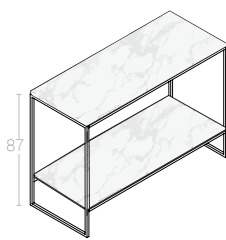

ENCIMERA SUPERIOR REF. PS

medidas	altura 87 cm	altura 81,5 cm
80 cm	885 €	875 €
100 cm	1.062 €	1.050 €
120 cm	1.239 €	1.225 €

ENCIMERA SUPERIOR REF. PE

medidas	altura 87 cm	altura 81,5 cm
80 cm	895 €	885 €
100 cm	1.074 €	1.062 €
120 cm	1.253 €	1.239 €

ENCIMERA SUPERIOR REF. CI

medidas	altura 87 cm	altura 81,5 cm
80 cm	905 €	895 €
100 cm	1.185 €	1.074 €
120 cm	1.267 €	1.253 €

Estructura de metal acabado negro mate / balda inferior incluida.

* Altura del mueble para lavabo de encastre o semiencastre

3. Seleccionar complementos

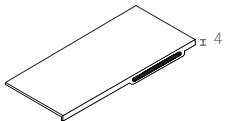

TOALLERO MECANIZADO REF. CI 77 €

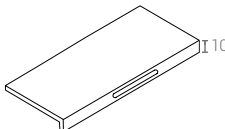

TOALLERO MECANIZADO REF. CI 77 €

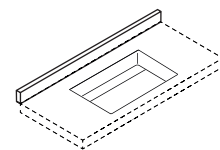

ZÓCALO
0.77 € / CM LINEAL

FICHA TÉCNICA DE PEDIDO

ACRYSPRINT®

CLIENTE.....

FECHA.....



Y06

Y07

WOK

WOK

WOK



BLANCO

BLANCO/GRAFITO

BLANCO/M.CALACATTA

BLANCO/M.MARQUINA

BLANCO/M.GRIS

BLANCO/M.BEIGE

40 x 40

40 x 40

75 x 30

75 x 30

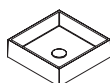

NICEA

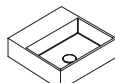

EGEO

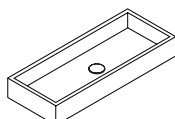

RODAS

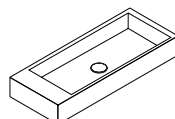

CALIPSO



ACRY MOLD

ACRY PRINT

ENCIMERA REF. PS

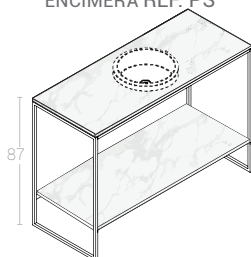

80 100 120

ENCIMERA REF. PS

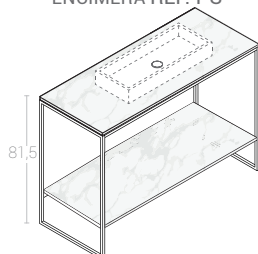

80 100 120

ENCIMERA REF. PE

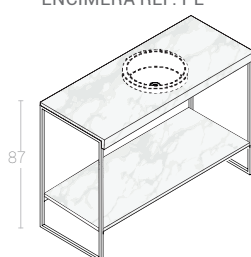

80 100 120

ENCIMERA REF. PE

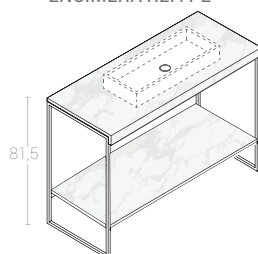

80 100 120

ENCIMERA REF. CI

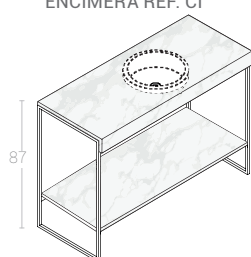

80 100 120

ENCIMERA REF. CI

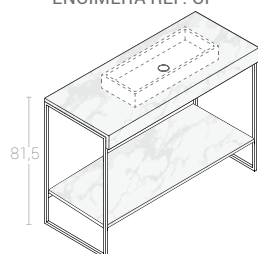

80 100 120

COLOR

- CALACATTA
- MARQUINA
- TRAVERTINO GRIS
- TRAVERTINO BEIGE

ACRY PRINT

POSICION TOALLERO

REF. CI

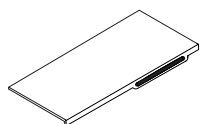

- cent
- dch
- izq
- doble

SIN toallero

REF. CI

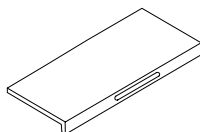

- cent
- dch
- izq
- doble

SIN toallero

POSICION LAVABO

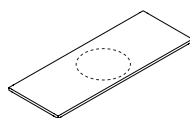

cent

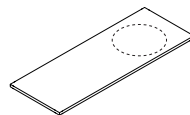

dch

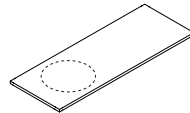

izq

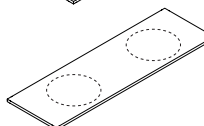

2 SENOS

excepto: Rodas, Calipso

POSICION AGUJERO GRIFO

izq cent dch sin

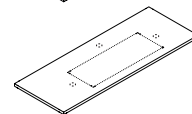
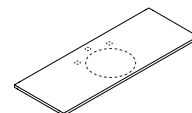

ZOCALO

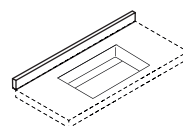

SI
NO

1. Seleccionar lavabo

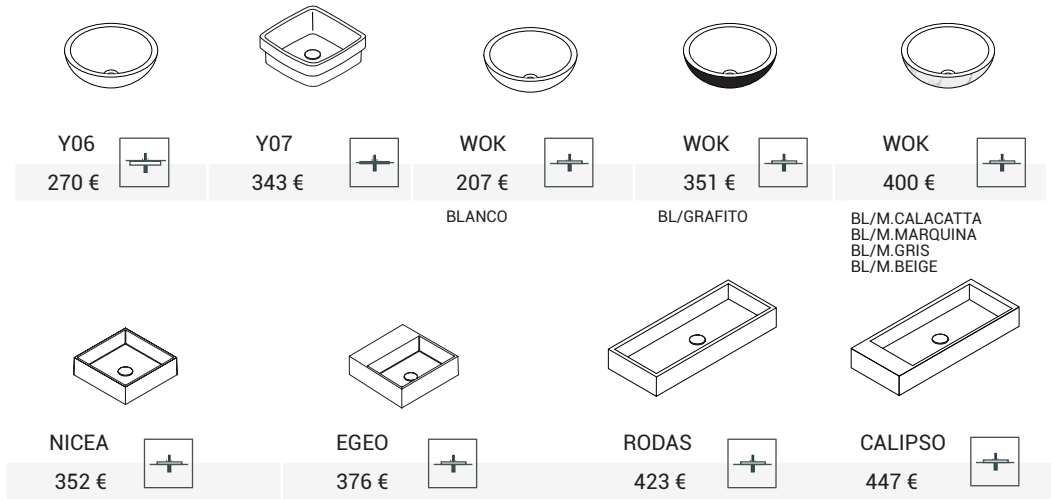

2. Seleccionar encimera y medidas

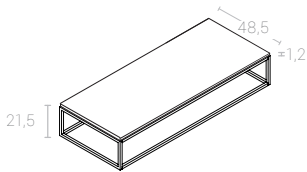

ref. SR

ENCIMERA SUPERIOR REF. SR		Estructura de metal acabado negro mate.
80 cm	403 €	
100 cm	464 €	
120 cm	517 €	

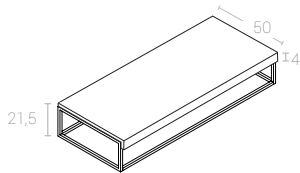

ref. SE

ENCIMERA SUPERIOR REF. SE		Estructura de metal acabado negro mate.
80 cm	414 €	
100 cm	474 €	
120 cm	527 €	

3. Seleccionar complementos

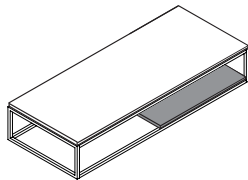

BALDA INFERIOR MUEBLE 120	
BALDA 50 cm	128 €

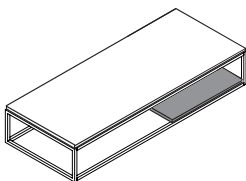

BALDA INFERIOR MUEBLE 100	
BALDA 40 cm	112 €

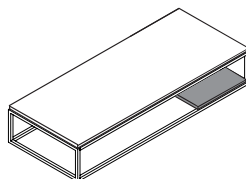

BALDA INFERIOR MUEBLE 80	
BALDA 30 cm	101 €

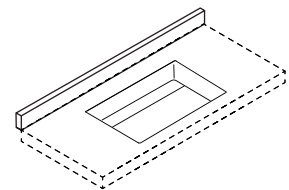

ZÓCALO
0.77 € / CM LINEAL

FICHA TÉCNICA DE PEDIDO

CLIENTE

FECHA

ACRYMOLD®
SOLID SURFACE

Ø35



Y06



40 x 40



Y07



Ø37,5

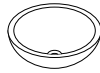

WOK



Ø37,5



WOK



Ø37,5



WOK



ACRY
PRINT

40 x 40

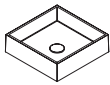

NICEA



40 x 40

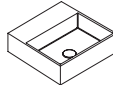

EGEO



75 x 30

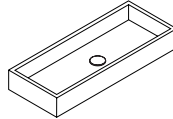

RODAS



75 x 30

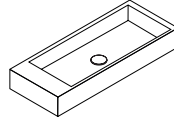

CALIPSO



ENCIMERA REF. SR

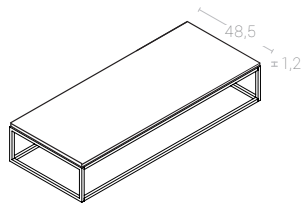

80 100 120



ENCIMERA REF. SE

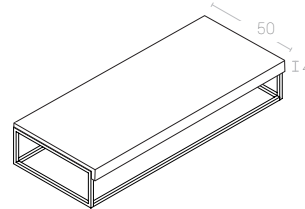

80 100 120



BALDA INFERIOR

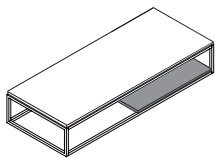

MUEBLE 120
50 cm

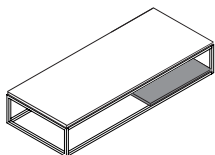

MUEBLE 100
40 cm

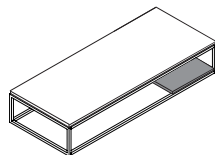

MUEBLE 80
30 cm

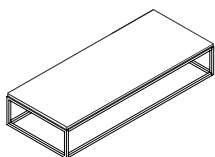

SIN balda



POSICION LAVABO

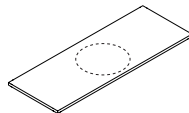

cent

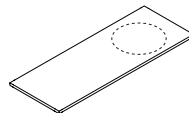

dch

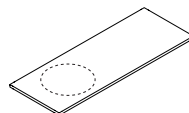

izq

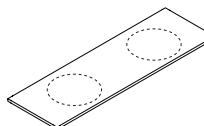

2 SENOS

POSICION AGUJERO GRIFO

izq cent dch sin

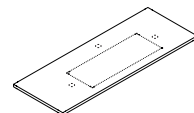
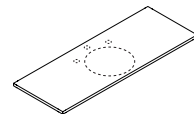

ZOCALO

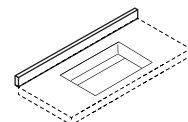

SI
NO

excepto: Rodas, Calipso

1. Seleccionar lavabo

Y06 270 €	Y07 343 €	WOK 207 €	WOK 351 €	WOK 400 €
		BLANCO	BL/GRAFITO	BL/M.CALACATTA BL/M.MARQUINA BL/M.GRIS BL/M.BEIGE
NICEA 352 €	EGEO 376 €	RODAS 423 €	CALIPSO 447 €	

2. Seleccionar encimera y medidas

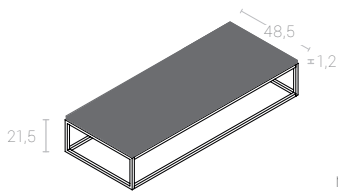

ref. PS

ENCIMERA SUPERIOR REF. PS		Estructura de metal acabado negro mate.
80 cm	361 €	
100 cm	411 €	
120 cm	452 €	

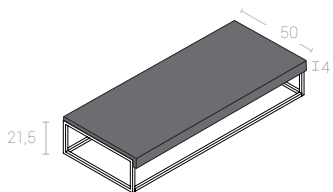

ref. PE

ENCIMERA SUPERIOR REF. PE		Estructura de metal acabado negro mate.
80 cm	371 €	
100 cm	421 €	
120 cm	463 €	

3. Seleccionar complementos

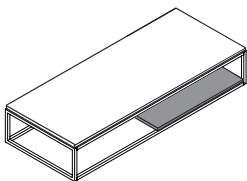

BALDA INFERIOR MUEBLE 120	
BALDA 50 cm	105 €

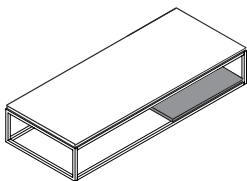

BALDA INFERIOR MUEBLE 100	
BALDA 40 cm	94 €

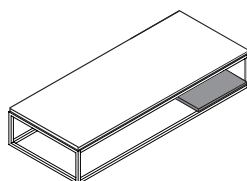

BALDA INFERIOR MUEBLE 80	
BALDA 30 cm	82 €

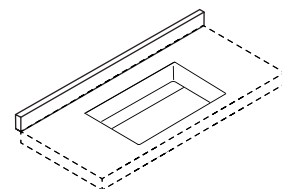

ZÓCALO
0.77 € / CM LINEAL

FICHA TÉCNICA DE PEDIDO

ACRYSTONE®

CLIENTE..... FECHA.....



Y06

Y07

WOK

WOK

WOK



BLANCO

BLANCO/GRAFITO

BLANCO/M.CALACATTA

BLANCO/M.MARQUINA

BLANCO/M.GRIS

BLANCO/M.BEIGE

ACRY
PRINT

ACRY
MOLD

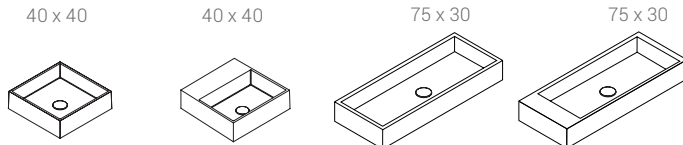

NICEA

EGEO

RODAS

CALIPSO



ENCIMERA REF. PS

ENCIMERA REF. PE

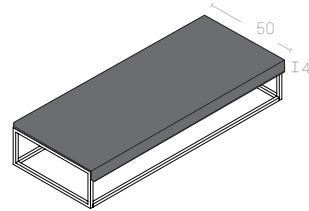
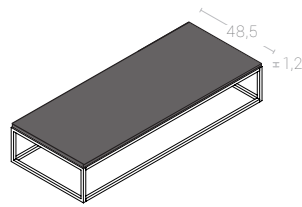

80 100 120

80 100 120



COLOR



BLANCO



MARFIL



BEIGE



CAPUCCINO



FANGO



GRIS PERLA



CEMENTO



BASALTO



ANTRACITA



GRAFITO



RAL

ACRY
STONE

BALDA INFERIOR

POSICON LAVABO

POSICON AGUJERO GRIFO

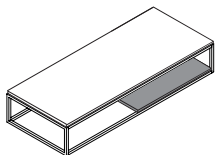

MUEBLE 120
50 cm

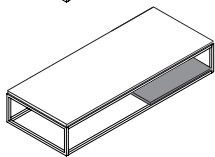

MUEBLE 100
40 cm

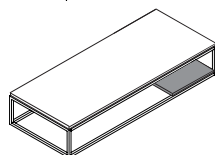

MUEBLE 80
30 cm

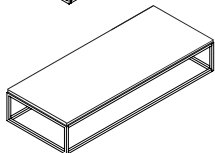

SIN balda

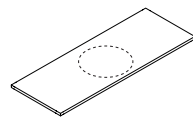

cent

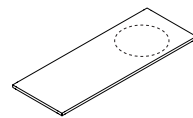

dch

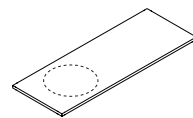

izq

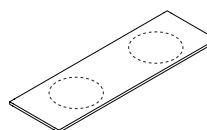

2 SENOS

izq cent dch sin

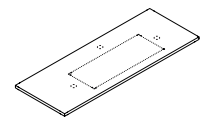
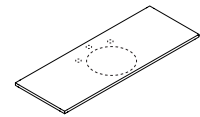

ZOCALO

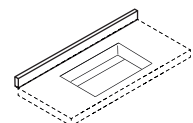

SI
NO

excepto: Rodas, Calipso

1. Seleccionar lavabo

Y06 270 €	Y07 343 €	WOK 207 €	WOK 351 €	WOK 400 €
		BLANCO	BL/GRAFITO	BL/M.CALACATTA BL/M.MARQUINA BL/M.GRIS BL/M.BEIGE

NICEA 352 €	EGEO 376 €	RODAS 423 €	CALIPSO 447 €

2. Seleccionar encimera y medidas

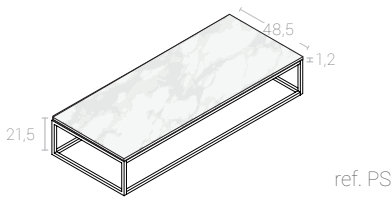

ENCIMERA SUPERIOR REF. PS		Estructura de metal acabado negro mate.
80 cm	463 €	
100 cm	556 €	
120 cm	648 €	

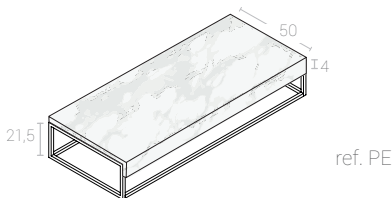

ENCIMERA SUPERIOR REF. PE		Estructura de metal acabado negro mate.
80 cm	473 €	
100 cm	567 €	
120 cm	662 €	

3. Seleccionar complementos

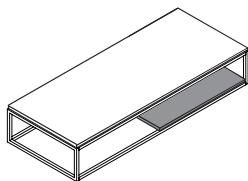

BALDA INFERIOR MUEBLE 120	
BALDA 50 cm	158 €

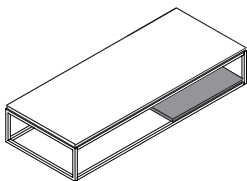

BALDA INFERIOR MUEBLE 100	
BALDA 40 cm	144 €

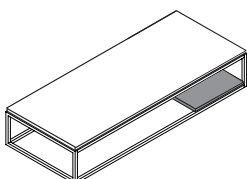

BALDA INFERIOR MUEBLE 80	
BALDA 30 cm	130 €

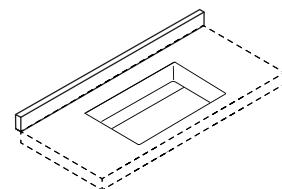

ZÓCALO
0.77 € / CM LINEAL

FICHA TÉCNICA DE PEDIDO

ACRYPRINT

CLIENTE FECHA



Y06 Y07 WOK WOK WOK

- BLANCO
- BLANCO/GRAFITO
- BLANCO/M.CALACATTA
- BLANCO/M.MARQUINA
- BLANCO/M.GRIS
- BLANCO/M.BEIGE

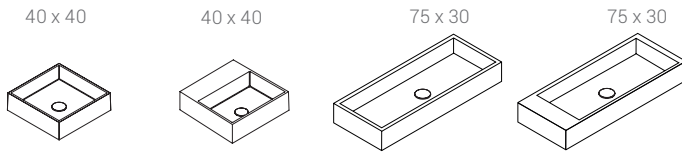

NICEA EGEO RODAS CALIPSO



ENCIMERA REF. PS

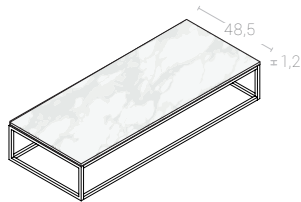

80 100 120



ENCIMERA REF. PE

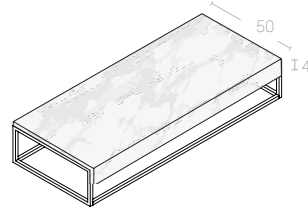

80 100 120



COLOUR

- CALACATTA BL
- MARQUINA NG
- TRAVERTINO GRIS
- TRAVERTINO BEIGE

BALDA INFERIOR

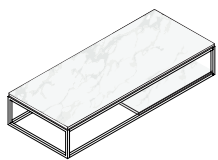

MUEBLE 120
50 cm

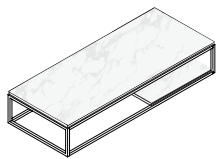

MUEBLE 100
40 cm

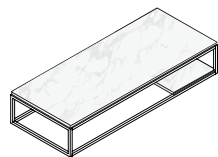

MUEBLE 80
30 cm

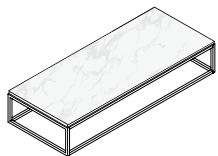

SIN balda

POSICION LAVABO

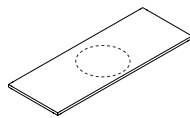

cent

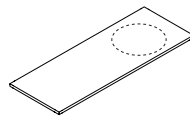

dch

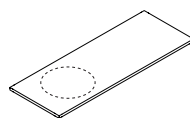

izq

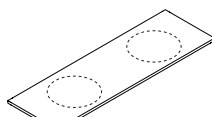

2 SENOS

POSICION AGUJERO GRIFO

- izq
- cent
- dch
- sin

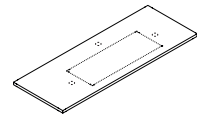
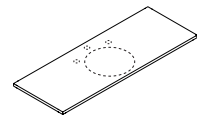

ZOCALO

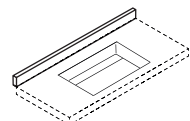

- SI
- NO

excepto: Rodas, Calipso

INFORMACIÓN TÉCNICA

PLATOS DE DUCHA

NOVA 

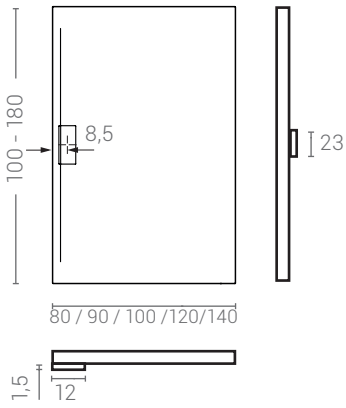

COTTON 

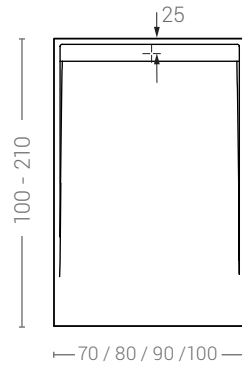

MIRAGE

 3 cm.

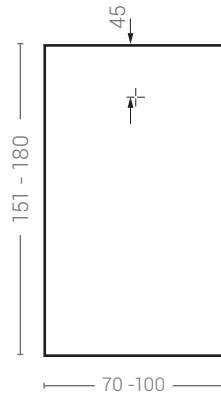
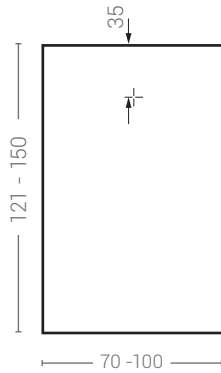
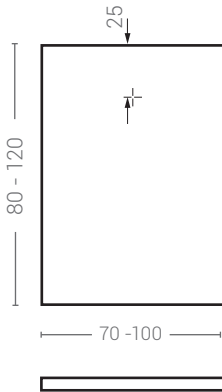

CENTURIA SMOOTH NOX

 3 cm.

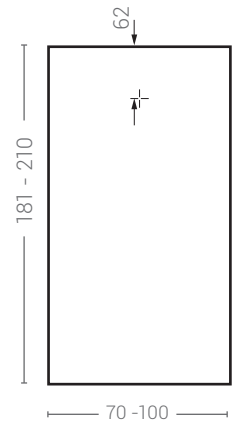
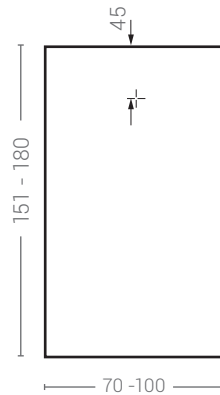
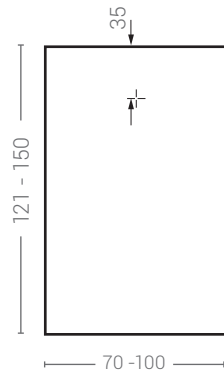
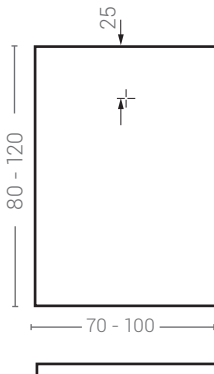

PLATOS DE DUCHA

CENTURIA STONE NOX

3 cm.

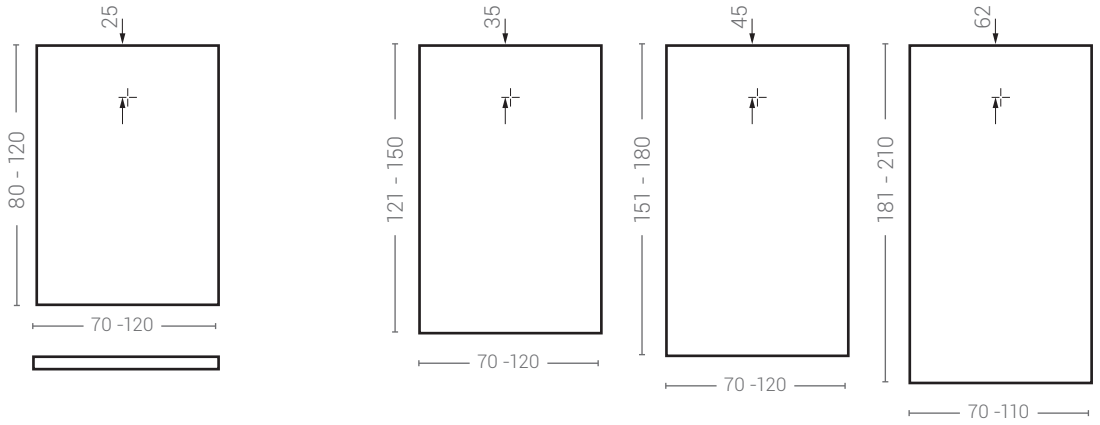

CENTURIA SLATE NOX

3 cm.

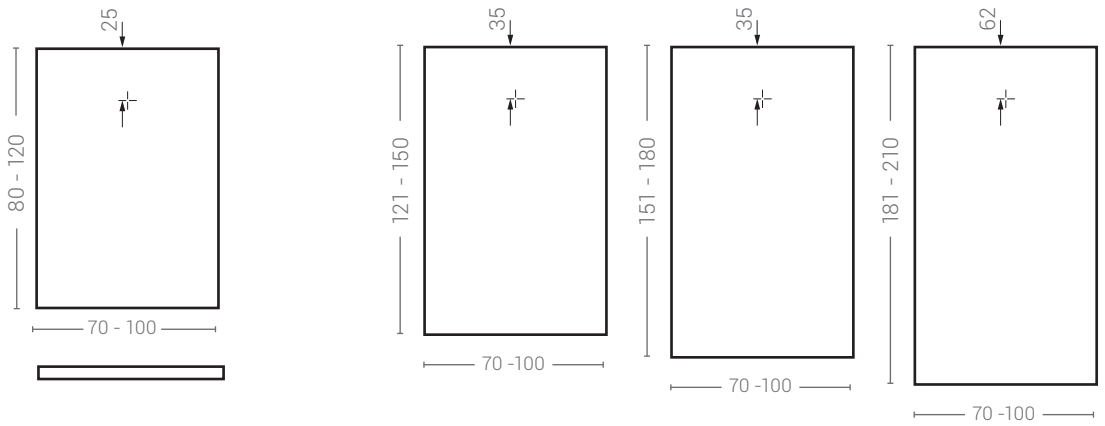

CENTURIA STONE COVER

3 cm.

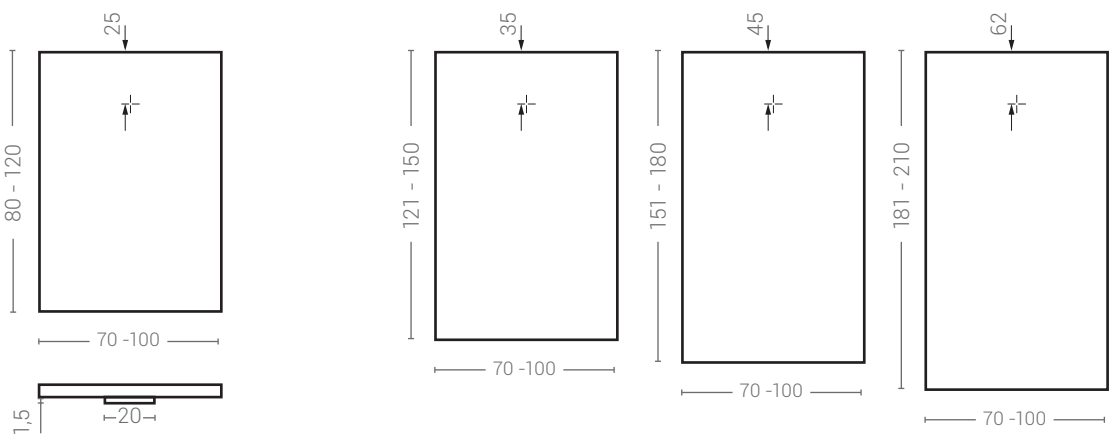

PLATOS DE DUCHA

ZEUS

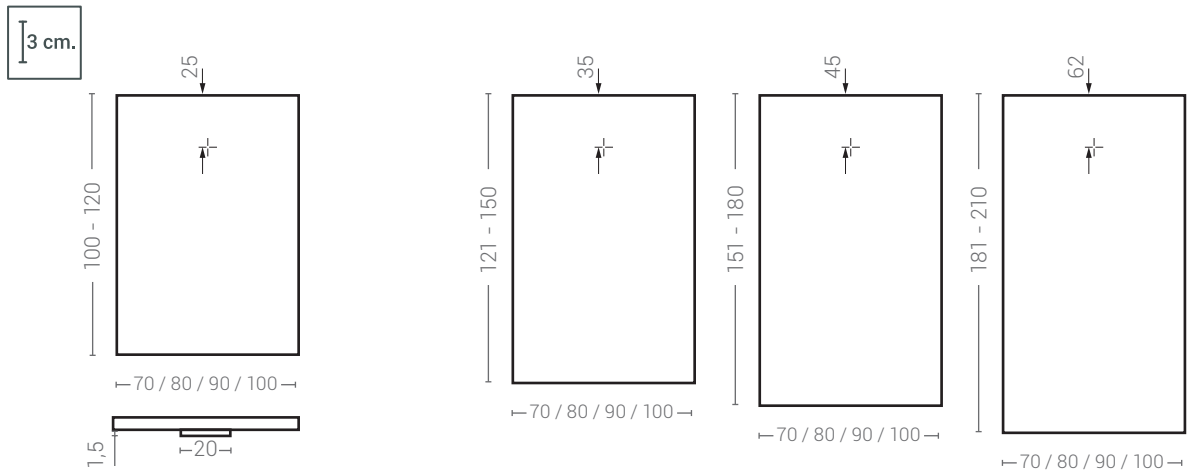

LICEO

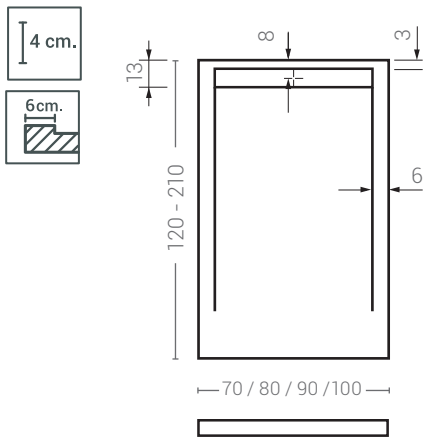

ARES

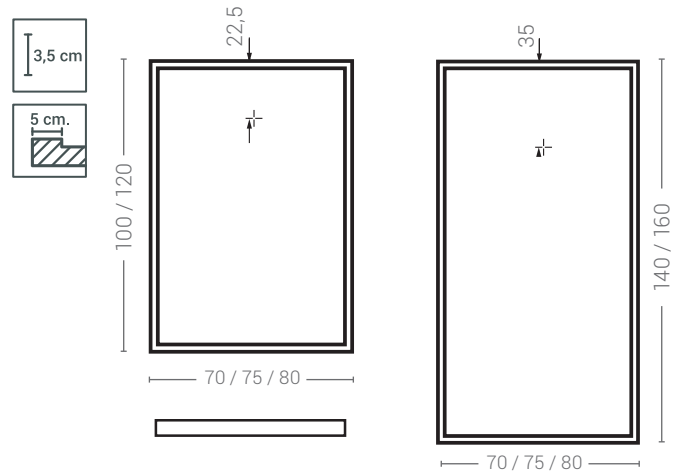

ANDROMEDA

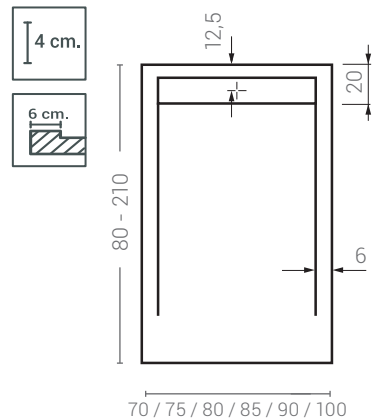

COLISEO STONE NOX

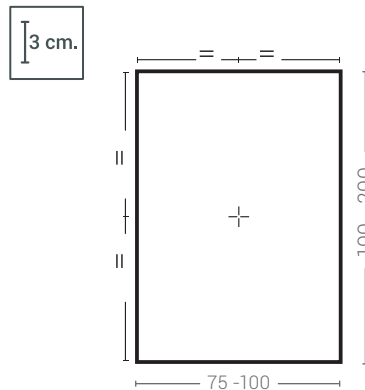

COLISEO STONE COVER

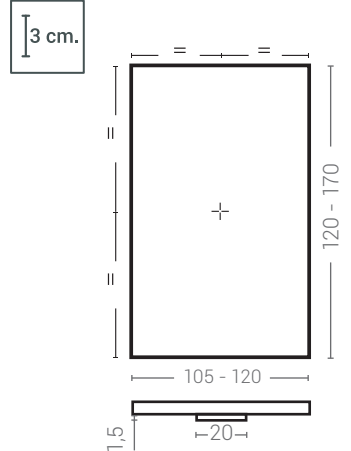

PLATOS DE DUCHA

MALENKE

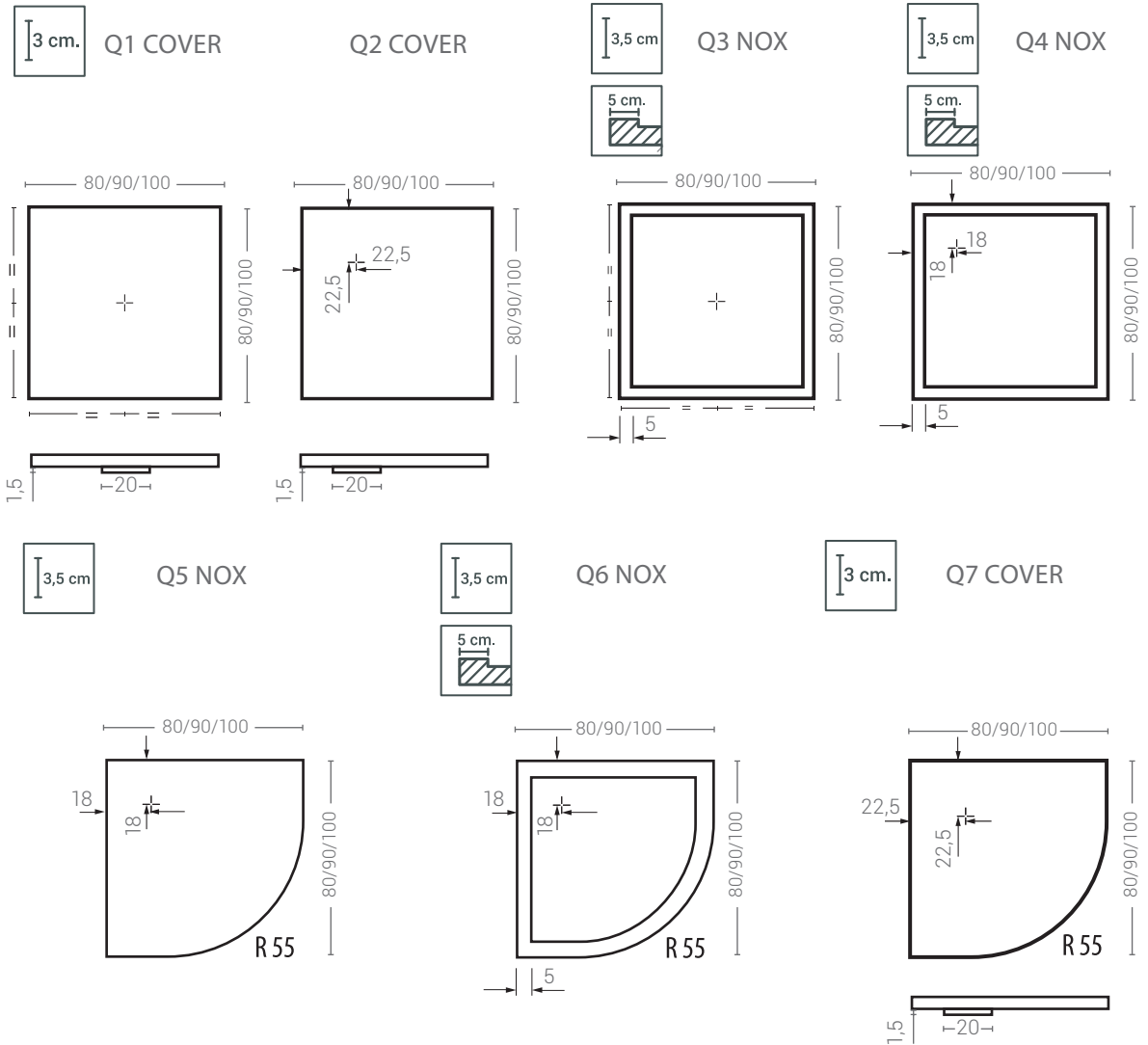

GRILLES/COVER

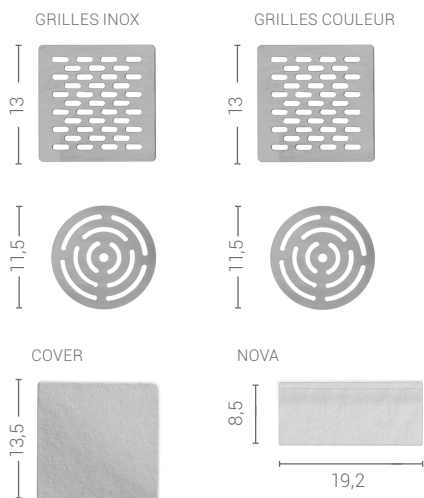

ANDROMEDA

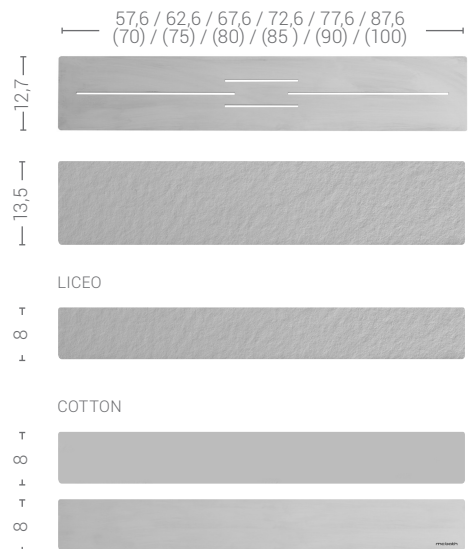

LAVABOS ESTANDAR

ACRYMOLD®
SOLID SURFACE

CORSO

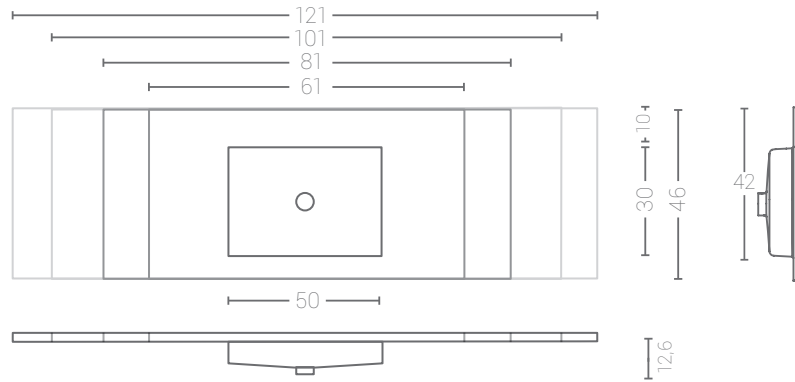

ASTRO

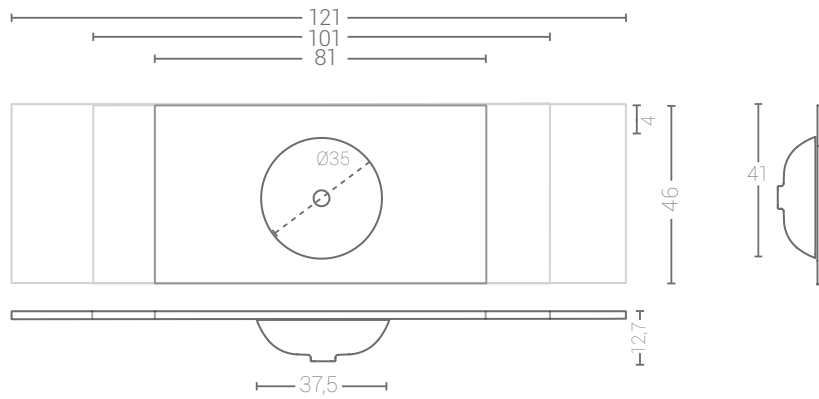

OCEAN 80

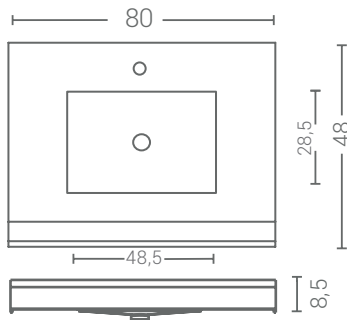

OCEAN 50

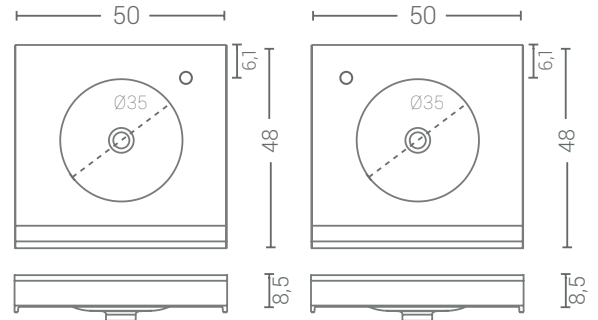

*Agujero IZQ/DCH

*Agujero IZQ/DCH

ULISES

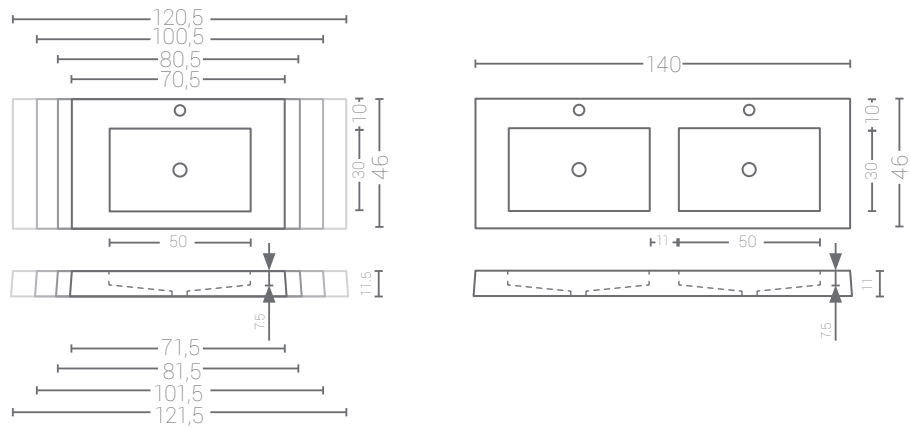

MINOS

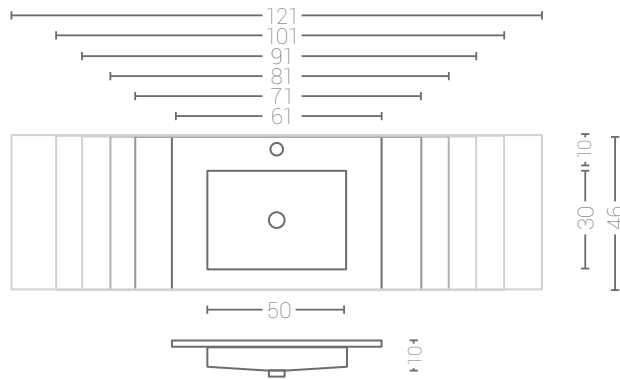

PERSEO

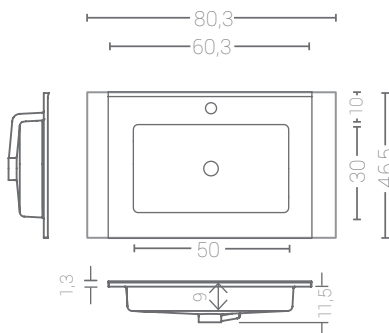

PERSEO XL

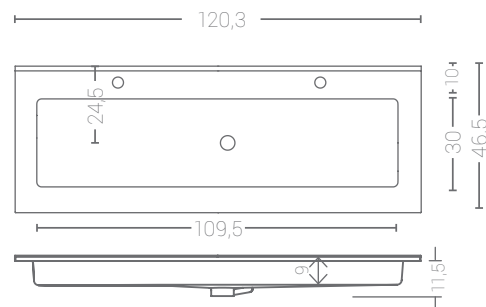

PERSEO 2.0

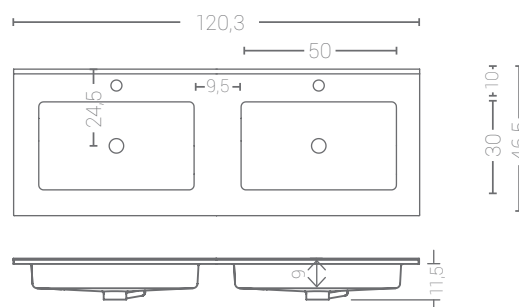

PUZZLE

ACRYMOLD®
SOLID SURFACE

Y01

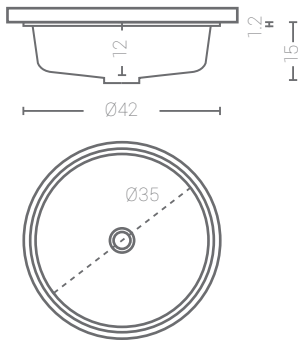

Y02

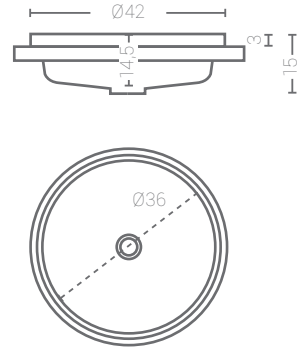

Y03

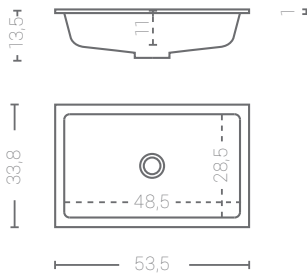

Y04

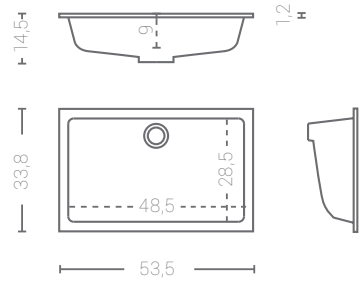

Y05

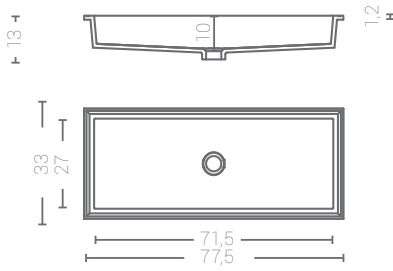

Y06

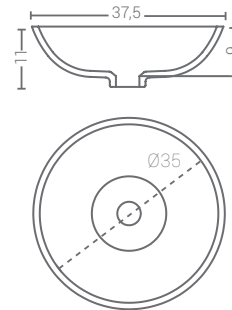

Y07 / ENEA

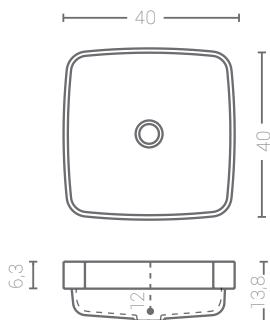

Y08

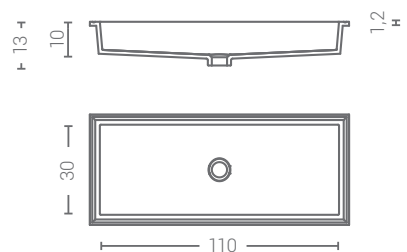

Y09

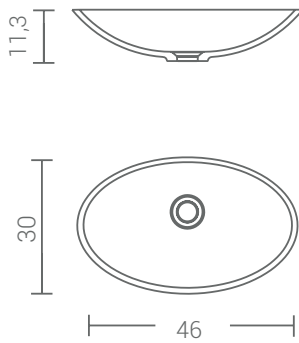

Y10

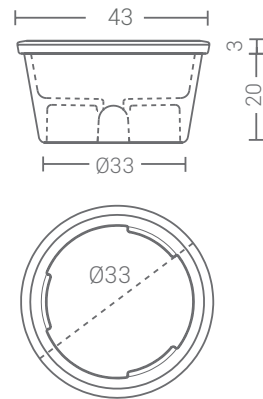

DELIOS

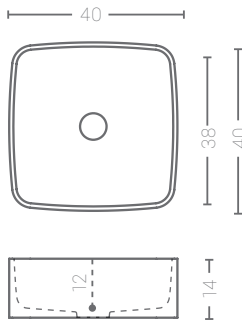

WOK

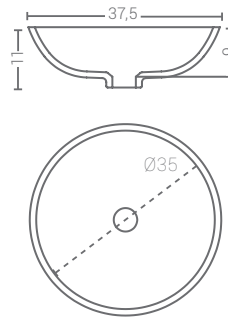

CRETA

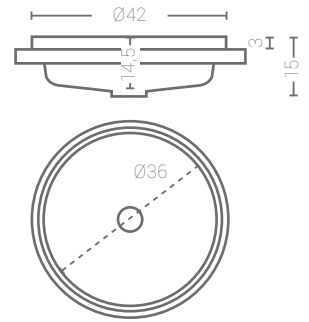

NICEA

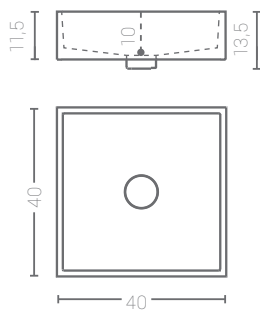

RODAS

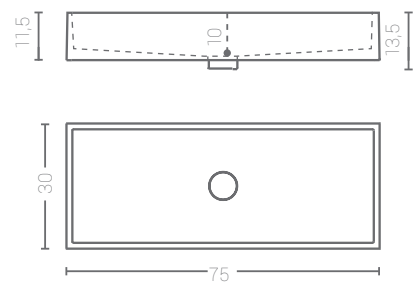

EGEO

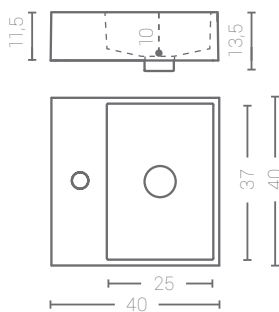

CALIPSO

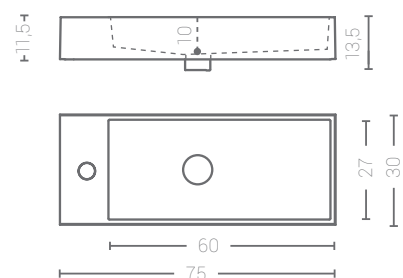

LAVABOS

ACRYMOLD®

SOLID SURFACE

ARGOS

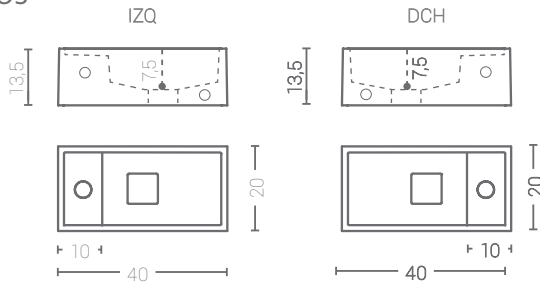

TESEO

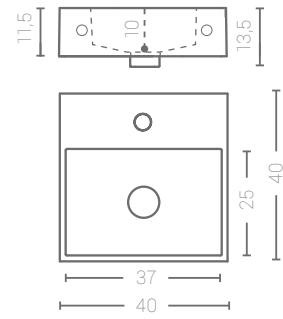

ITACA

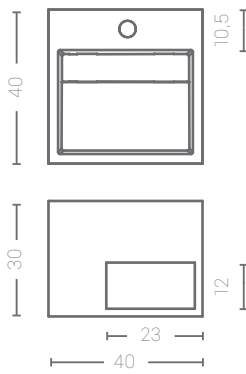

TEBAS

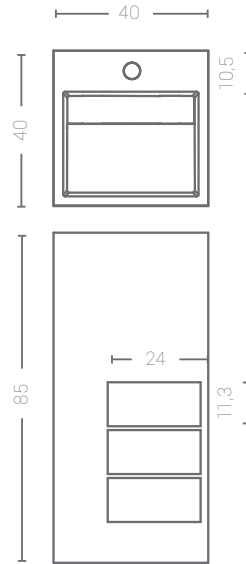

ESS

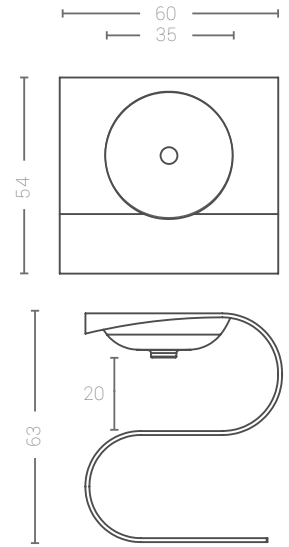

COLUMNA

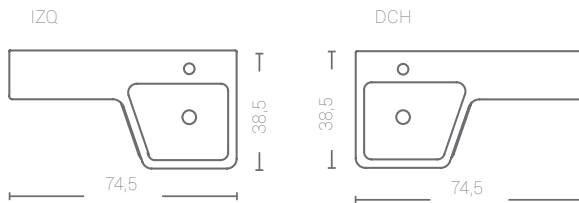

BAÑERAS

OVAL

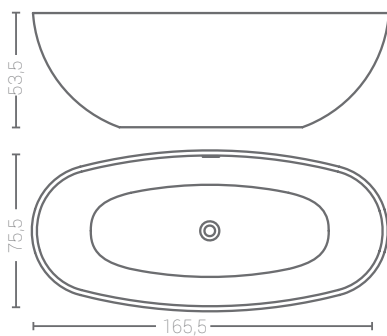

BLOCK

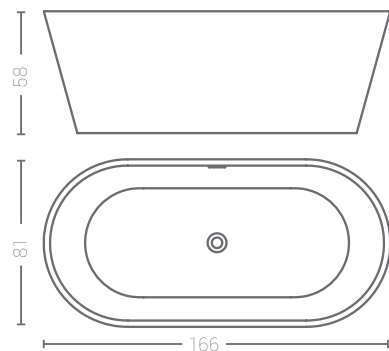

MUEBLES

SCALA

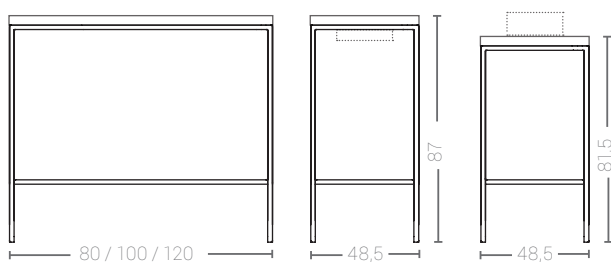

AIRE

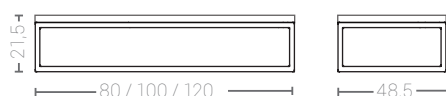

VÁLVULAS

VIEGA 60 HORIZONTAL. 0,55L/S

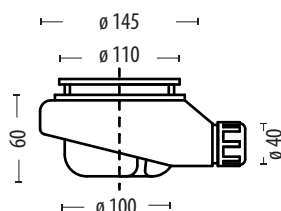

VIEGA 80 HORIZONTAL. 0,64L/S

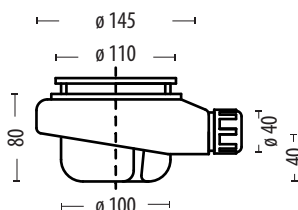

VIEGA 80 VERTICAL. 0,64L/S

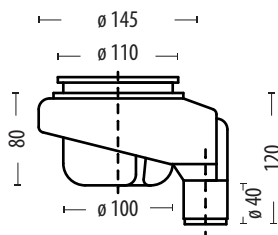

GEBERIT 80. 0,5L/S

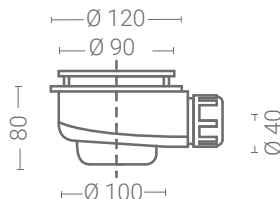

VIEGA 50 HORIZONTAL 0,7L/S
* LICEO

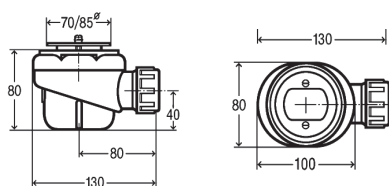

VIEGA 50 VERTICAL 0,7L/S
* LICEO

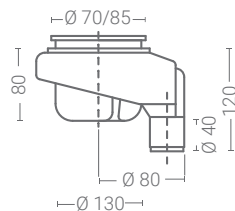

MACALPINE 70. 0,5L/S

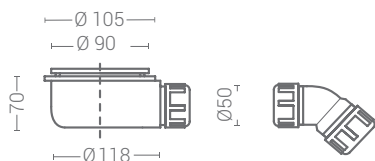

MACALPINE 50. 0,5L/S

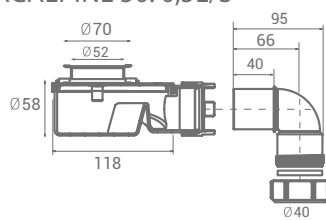

EXPOSITORES

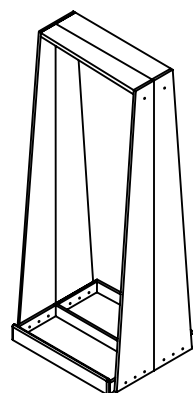
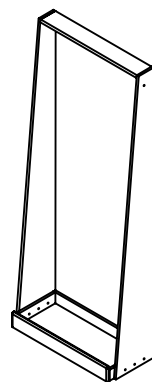

EXPOSITOR 1 PLATO

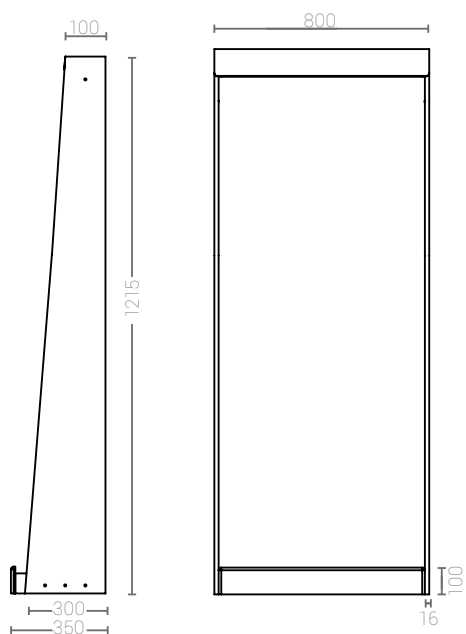

EXPOSITOR 2 PLATO

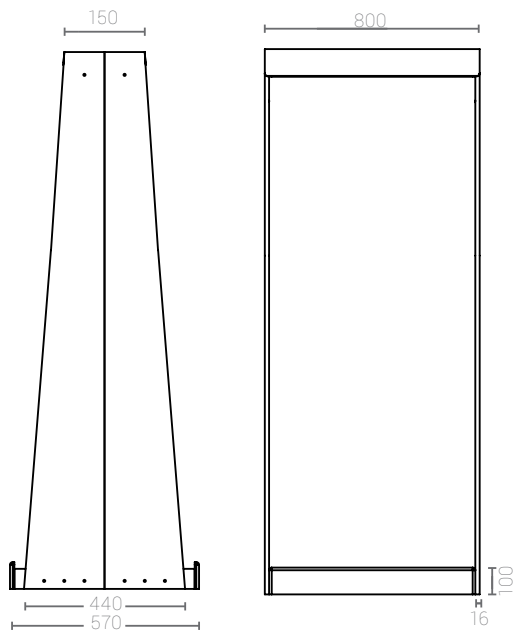

CONDICIONES GENERALES DE VENTA

Las condiciones que se expresan a continuación son aplicables a todos los contratos/pedidos y por lo tanto se considera que estas son conocidas y aceptadas por el comprador al transmitir el pedido. Todos los pedidos efectuados por nuestros Agentes, Representantes, Vendedores y otros se considerarán válidos, siempre que estos sean enviados a MOLDCOM COMPOSITES S.L. en soporte papel o electrónico imprimible independientemente del formato.

PRECIOS

Todos los precios reflejados en esta tarifa son precios recomendados de venta al público sin incluir el IVA u otros impuestos aplicables. MOLDCOM COMPOSITES S.L. no se hace responsable de los errores eventuales que pudieran surgir o de los errores de cálculo en el momento de realizar un presupuesto. Los precios están sujetos a posibles modificaciones por variaciones en los costes de materia prima, energía u otros, según las circunstancias del mercado. Las nuevas tarifas se aplicarán a todos los pedidos enviados después de la modificación de precios.

PERIODO DE VIGENCIA

Esta tarifa entra en vigor a partir del 15 de julio de 2019 hasta nuevo aviso, momento en el cual pasará a anular las anteriores. MOLDCOM COMPOSITES S.L. se reserva el derecho a actualizarla sin previo aviso en cualquier momento si fuera necesario debido a variaciones del mercado.

REALIZACIONES DE PEDIDOS

Todos los pedidos deben ser remitidos a nuestro Departamento Comercial o a nuestros Agentes comerciales o representantes, tratando de evitar la duplicidad en esta operación y por tanto el envío a ambos. Los pedidos serán aceptados en cualquier formato y sólo se aceptarán en soporte papel o en soporte electrónico, siempre que este sea imprimible. En ningún caso se aceptarán pedidos realizados por teléfono.

A la recepción del pedido nuestro Departamento Comercial introducirá el mismo en el sistema, enviando una confirmación de pedido si así lo desea el cliente. Es importante especificar correctamente todas las características de los artículos que desee solicitar, así como las condiciones de venta si son diferentes a las establecidas; para esto cuenta con la ayuda de nuestro Departamento Comercial que muy gustosamente atenderá sus sugerencias y dudas.

Los pedidos con condiciones de expedición 48 horas se tendrán que confirmar por escrito por parte de MOLDCOM COMPOSITES S.L.

MODIFICACIONES O ANULACIONES DE PEDIDOS

No se admitirán anulaciones ni modificaciones de los pedidos una vez hayan transcurrido:

24 horas para todos los artículos

En el caso de anulaciones, cancelaciones o modificaciones en el pedido transcurrido este tiempo, se deberá abonar el 20% del total de los productos cancelados/modificados a MOLDCOM COMPOSITES S.L. En cualquier caso estas anulaciones, cancelaciones o modificaciones de pedido deberán ser enviadas a nuestro Departamento Comercial por escrito.

DEVOLUCIONES

Sólo se admitirán devoluciones que hayan sido cursadas previa autorización de MOLDCOM COMPOSITES S.L. No se aceptarán devoluciones que no hayan sido comunicadas y aceptadas por nuestro Departamento Comercial. La mercancía debe ser devuelta a nuestras instalaciones de RIBARROJA (Valencia) y llegar en perfectas condiciones. MOLDCOM COMPOSITES S.L. devolverá el importe de ésta una vez se haya inspeccionado.

ARTÍCULOS ESPECIALES (NO ESTÁNDAR)

Los artículos con medidas especiales o diferentes a aquellos que figuran en nuestra tarifa serán admitidos con reserva por nuestro Personal de Ventas. Nuestro Departamento Comercial estará encantado de atender cualquier duda, pregunta o aclaración que pudiera surgir.

CARACTERÍSTICAS Y DATOS TÉCNICOS DEL PRODUCTO

Toda la información técnica que aparece en esta tarifa es orientativa. MOLDCOM COMPOSITES S.L. se reserva el derecho a modificar todo aquello que considere oportuno siempre que no afecte a las características esenciales ni a la calidad del producto recogido en la presente tarifa.

TOLERANCIAS DIMENSIONALES

Debido a los materiales utilizados y al proceso de fabricación utilizado para todos nuestros productos, estos podrán tener una tolerancia de +/- 0,3% con respecto a las dimensiones solicitadas.

EMBALAJE

Todos nuestros productos son embalados debidamente de acuerdo con los estándares de la industria. La mercancía es expedida con film protector, cartón, madera y cantos protegidos en cajas de madera. Los costes del embalaje utilizado están incluidos en el precio mostrado en esta tarifa. Cualquier requerimiento de embalaje especial o adicional por parte del cliente será facturado de acuerdo con los costes de este embalaje.

CONDICIONES GENERALES DE VENTA

TRANSPORTE

Los precios indicados en esta tarifa incluyen el transporte (si de esta manera ha sido acordado el suministro) hasta el destino previamente acordado con el cliente o destinos diferentes siempre que ello no suponga un incremento del transporte, en cuyo caso será repercutido por MOLDCOM COMPOSITES S.L. Los portes que conlleven los cambios de dirección de entrega realizados una vez expedida la mercancía serán aplicados en la factura. Para Canarias, Baleares, Ceuta y Melilla se acordará entre ambas partes los gastos de transporte.

PLAZOS DE ENTREGA

Todos los pedidos recibidos son confirmados vía mail o vía fax con fecha aproximada de entrega. No se aceptarán reclamaciones basadas en estas fechas orientativas. La salida de fábrica es de 48 horas desde la confirmación del pedido para los artículos con condiciones 48 horas.

INSTALACIÓN Y MONTAJE

Los productos mcbath® exigen la realización de la instalación y montaje por personal cualificado y siguiendo siempre las instrucciones que se suministran con cada uno de los artículos. Una instalación o montaje inadecuado no quedará cubierta por la garantía de nuestros productos.

NOTA IMPORTANTE PARA LA INSTALACIÓN DE PLATOS DE DUCHA

El personal que instale el plato de ducha mcbath® debe verificar cuidadosamente el nivelado y la correcta evacuación del agua antes de alicatar, instalar una mampara o llevar a cabo cualquier otra obra o instalación. Si estas verificaciones no son realizadas correctamente, MOLDCOM COMPOSITES S.L. no se hará cargo de los costes que ello pueda ocasionar (desmontaje de mampara, azulejos, pavimento...).

ACEPTACIÓN DE PEDIDOS Y PAGOS

La aceptación de los pedidos y de las condiciones de pago acordadas se encuentra supeditada al resultado de la información comercial que MOLDCOM COMPOSITES S.L. se reserva el derecho de obtener. El incumplimiento de los pagos puede ser objeto de litigio.

CONDICIONES DE PAGO

Cualquier pago debe realizarse en un máximo de 60 días desde la fecha de factura. Se efectuará un descuento del 2% por pronto pago (dentro de los 15 días desde fecha factura). GARANTÍA La garantía será de 5 años desde la fecha de factura e incluye los defectos de fabricación. Esta garantía no incluye la mala manipulación, uso o instalación de nuestros productos. Una vez recibida la mercancía verifique que el producto se encuentre en perfectas condiciones dentro de las 24 horas. Todos nuestros productos son sometidos a un estricto control de calidad antes de su embalaje.

LITIGIOS/CONTROVERSIAS

Es voluntad de MOLDCOM COMPOSITES S.L. resolver por la vía amistosa las posibles divergencias que pudieran surgir con nuestros clientes. No obstante, para cualquier tipo de litigio o controversia que pudiera plantearse entre las partes en relación con la interpretación y cumplimiento del presente contrato, ambas partes acuerdan someterse a un arbitraje de equidad en la forma establecida en la Ley de Arbitraje de 5 de diciembre de 1988 del Reino de España.