

catálogo  
general

**fominaya**®  
*Original*  *Since 1939*

SISTEMAS INSTALACIONES SANITARIOS 2020

*Made in Spain*



**Fundada en 1939, Fominaya® es una empresa española especialista en diseño, fabricación, distribución y comercialización de artículos destinados a instalaciones sanitarias (sistemas de descarga, sistemas de alimentación, sistemas de accionamiento para cisternas sanitarias...), artículos destinados a instalaciones de agua y accesorios. En la actualidad se encuentra presente en más de cuarenta países repartidos por todo el mundo.**

**La gama de productos Fominaya® cumple estrictamente con la filosofía y estrategia que le ha hecho convertirse en referente:**

- **INNOVACIÓN + DESARROLLO**
- **RESPONSABILIDAD MEDIOAMBIENTAL**
- **NUESTRO OBJETIVO: LA EXCELENCIA**



COMPROMISO I+D  
MEDIOAMBIENTAL



SOLUCIONES DE  
AHORRO DE AGUA



PLÁSTIC  
FREE



RECYCLED  
PAPER





# fominaya®

## SAVING WATER AROUND THE WORLD

Portugal, France, Morocco, Tunisia, Algeria,  
Libya, Syria, Lebanon, Russia, Malta, Albania,  
Romania, Cyprus, Czech Republic, Gabon, Réunion,  
Mauritius, Madagascar, Tahiti, Jordan, Kuwait, Qatar,  
Bahrain, India, Saudi Arabia, United Arab Emirates,  
Italy, Belgium, United Kingdom, Kenya, Tanzania,  
Uganda, Kazakhstan, Kyrgyzstan, Turmenistan, Polynesia,  
Suriname, Sri Lanka, Colombia, Peru, Cuba, Mexico,



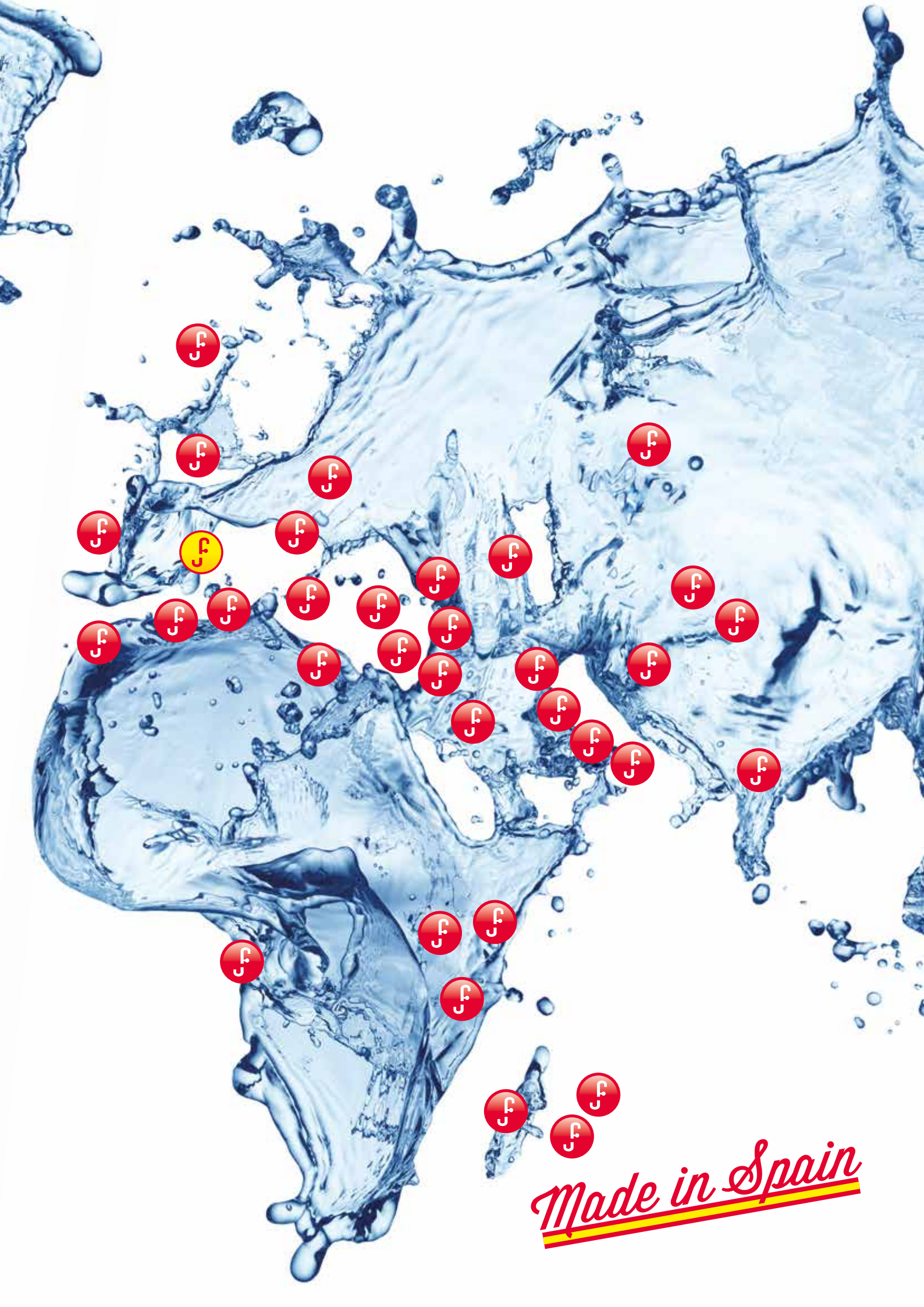

*Made in Spain*



**INNOVATE SME**

Valid until Jul 4th 2020



GOBIERNO DE ESPAÑA

MINISTERIO DE ECONOMÍA, INDUSTRIA Y COMPETITIVIDAD

DNV-GL

# MANAGEMENT SYSTEM CERTIFICATE

Número de certificado/Certificate No.: 248742-2017-AQ-1BE-ENAC  
Fecha Inicial de Certificación/Initial date: 03 marzo 2000  
Valides:/Valid: 16 noviembre 2017 - 16 noviembre 2020

Se certifica que el sistema de gestión de/This is to certify that the management system of  
**FOMINAYA, S.A.**  
Ctra. del Pla, s/n, 46117, Bètera, Valencia, Spain

es conforme a la Norma del Sistema de Gestión de Calidad/  
has been found to conform to the Quality Management System standard:  
**ISO 9001:2015**

Este certificado es válido para el siguiente campo de aplicación:

**El diseño, fabricación y la comercialización de artículos de llenado y descarga para cisternas de inodoro y cisternas de doble pulsador empotradas a pared y sus accesorios. El diseño, la producción y la comercialización de accesorios para instalaciones de agua sanitarias.**

This certificate is valid for the following scope:

**The design, production and commercialization of flushing and filling articles for WC cisterns and concealed systems with double push button and their accessories and the design, production and commercialization of accessories for sanitary water installations.**

Lugar y fecha/Place and date:  
Barcelona, 31 octubre 2017



Oficina de emisión/  
For the Certification Body  
DNV GL - Business Assurance  
Edificio Inbes Mae Blau, C/ Garrotxa  
6-8, 3º 1º, El Prat de Llobregat,  
08820, Barcelona, Spain

Ana del Rio Salgado  
Representante de la dirección/  
Management Representative

El incumplimiento de las condiciones establecidas en el Contrato puede dar lugar a la cancelación del certificado/  
Lack of fulfillment of conditions as set out in the Certification Agreement may render this Certificate invalid.  
DNV GL BUSINESS ASSURANCE ESPAÑA, S.L.U. C/ Garrotxa, 6-8, 3º 1º, 08820, El Prat de Llobregat, Barcelona, Spain. TEL: +34 93 479 26 00.  
www.dnvgl.es/assurance

**fominaya**<sup>®</sup>  
*Original* *Since 1939*

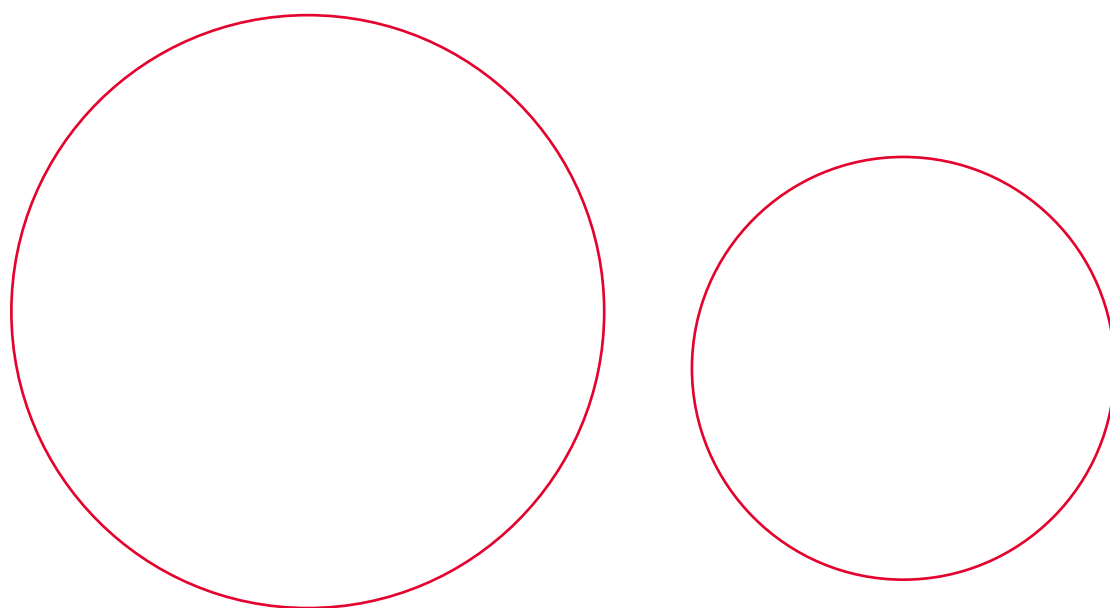

**SISTEMAS INSTALACIONES SANITARIOS 2020**

*Made in Spain*

# NILO BIDÉ

## BASTIDOR SUJECIÓN BIDÉ

Bastidor metálico con regulación universal.  
Instalación de bidé suspendido en pared sólida o pladur.  
Para bidé suspendido con distancia 180 ó 230 mm.



Bastidor universal altura 114 cm.  
Soportes de pie galvanizados ajustables de 0 a 20 cm.  
Dos conexiones para instalación de las llaves de regulación entrada de agua en latón con R 1/2".  
La posición de la entrada es ajustable de 6 a 35 cm.  
Codo de salida bidet HPDE Ø 30-46 mm.  
Distancia de sujeción 18 ó 23 cm.  
Pintura electrostática, color gris.  
Peso máximo 400 Kg.  
No incluye accesorios de sujeción.

**CE-NILO-B**  
Ref. 0110400001  
**Packaging Caja**

1 uds/caja

**PVP: 114,90 €**

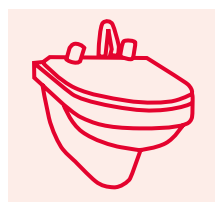

# NILO LAVABO

## BASTIDOR SUJECIÓN INODORO 13 CM

Bastidor metálico con regulación universal.  
Instalación de lavabo suspendido en pared sólida o pladur.  
Para lavabo suspendido con distancia entre 40 y 380 mm.



Bastidor universal altura 114 cm.  
Soportes de pie galvanizados ajustables de 0 a 20 cm.  
Dos conexiones para instalación de las llaves de regulación entrada de agua en latón con R 1/2".  
La posición de la entrada es ajustable de 6 a 35 cm.  
Codo de salida bidet HPDE Ø 32-44 mm.  
Pintura electrostática, color gris.  
No incluye accesorios de sujeción.

**CE-NILO-L**  
Ref. 0110300001  
**Packaging Caja**

1 uds/caja

**PVP: 119,90 €**

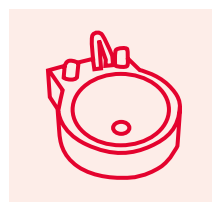





# NILO<sub>CE</sub>

## BASTIDOR SUJECCIÓN INODORO 12 CM

Regulación de la doble descarga: **PRODUCTO VERDE**.  
 Instalación de cisterna de WC en pared sólida o pladur.  
 Para WC suspendido con distancia 180 ó 230 mm.

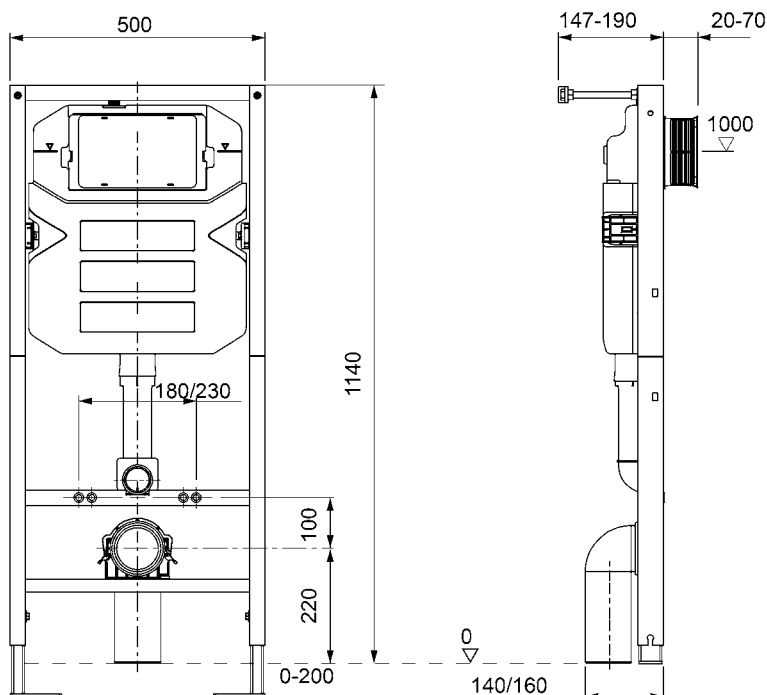

Descarga ajustable para 6/3 ó 4,5/3 l.  
 Set de conexión de WC Ø 90 mm.  
 Codo de salida WC en PVC ó HDPE Ø 110 mm.  
 Soportes pie galvanizados ajustables de 0 a 20 cm.  
 Cisterna empotrada aislada de la condensación.  
 Descargador de doble pulsador ajustable.  
 Válvula regulación conexión suministro de agua R 1/2".  
 Tapón de protección para los tubos de descarga.  
 Tapa de protección para apertura de servicio.  
 Barras con rosca M 12 para sujeción en cerámica.  
 Pintura electrostática, color gris.  
 Peso máximo 400 Kg.  
 Incluye accesorios de sujeción.

**CE-NILO-I**  
**Ref. 0110220001**

**Packaging Caja**

1 uds/caja

**PVP: 174,90 €**

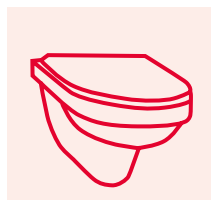



# ANNA<sub>CE</sub>

## BASTIDOR SUJECIÓN INODOROS 13 CM

Regulación de la doble descarga: **PRODUCTO VERDE**.  
 Instalación de cisterna de WC en pared sólida o pladur.  
 Accionamiento frontal o superior.

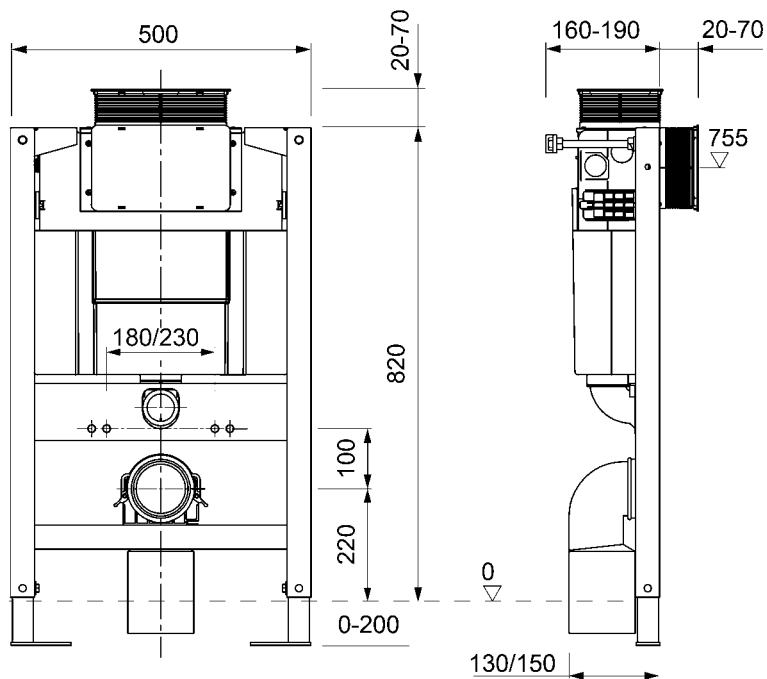

Descarga ajustable para 6/3 ó 4,5/3l.  
 Set de conexión de WC Ø 90 mm.  
 Codo de salida WC en PVC ó HDPE Ø 110 mm.  
 Soportes pie galvanizados ajustables de 0 a 20 cm.  
 Cisterna empotrada aislada de la condensación.  
 Descargador de doble pulsador ajustable.  
 Válvula regulación conexión suministro de agua R 1/2".  
 Tapón de protección para los tubos de descarga.  
 Tapa de protección para apertura de servicio.  
 Barras con rosca M 12 para sujeción en cerámica.  
 Peso máximo 400 Kg.  
 Incluye accesorios de sujeción.

**NOVEDAD  
2020**

**NILO-MINI**  
**Ref. 0110240001**  
**Packaging Caja**  
 1 uds/caja  
**PVP: 149,90 €**

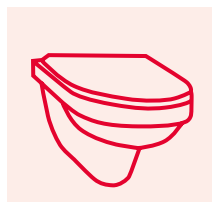



# VOLGA

## BASTIDOR SUJECIÓN INODORO

Bastidor metálico con regulación universal.  
Instalación de WC suspendido en pared sólida o pladur.  
Para WC suspendido con distancia 180 ó 230 mm.



Bastidor universal altura 52 cm.  
Soportes de pie galvanizados ajustables de 0 a 20 cm.  
Set de conexión de WC Ø 90 mm.  
Codo de salida WC en PVC ó HDPE Ø 110 mm.  
Pintura electrostática, color gris.  
Peso máximo 400 Kg.  
Incluye accesorios de sujeción.

**CE-VOLGA-I**  
Ref. 0110500001

**Packaging Caja**

1 uds/caja

**PVP: 114,90 €**

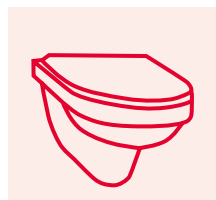

# VOLGA<sub>CE</sub>

## CISTERNA EMPOTRADA

Regulación de la doble descarga: **PRODUCTO VERDE**.  
Instalación de cisterna en pared sólida o pladur.  
Para WC sujeción a suelo.



Descarga ajustable para 6/3, 4,5/3 ó 4/2 l.  
Cisterna empotrada aislada de la condensación.  
Casco fabricado por Rotomoldeo (sin uniones).  
Descargador de doble pulsador ajustable.  
Grifo flotador llenado modelo servo silencioso.  
Válvula regulación conexión suministro de agua R 1/2".  
Tapón de protección para los tubos de descarga.  
Tapa de protección para apertura de servicio.  
Incluye accesorios de sujeción.

**CE-VOLGA-C**  
Ref. 0110110001

**Packaging Caja**

1 uds/caja

**PVP: 99,90 €**

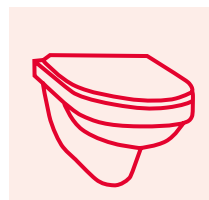



# PÜLSADORES

## PULSADOR MECÁNICO

Descarga interrumpible: **PRODUCTO VERDE**.  
 Soporte de fijación. Instalación rápida.  
 Incluye material de instalación.



**QÜADRIGA PQC-M-CE**

Ref. 0111110001

1 uds/caja

**PVP: 34,90 €**

Cromo Mate

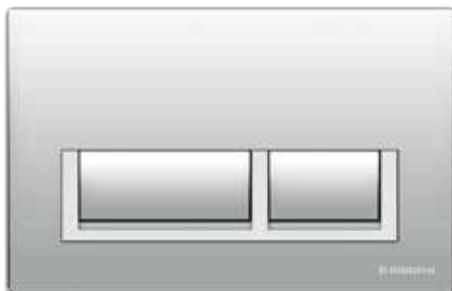

**QÜADRIGA PQC-B-CE**

Ref. 0111110002

1 uds/caja

**PVP: 34,90 €**

Cromo Brillo



**QÜADRIGA PQC-N-CE**

Ref. 0111110003

1 uds/caja

**PVP: 34,90 €**

Negro



**COLISEÜM PCO-M-CE**

Ref. 0111130001

1 uds/caja

**PVP: 35,90 €**

Cromo Mate



**COLISEÜM PCO-B-CE**

Ref. 0111130002

1 uds/caja

**PVP: 35,90 €**

Cromo Brillo



**COLISEÜM PCO-N-CE**

Ref. 0111130003

1 uds/caja

**PVP: 35,90 €**

Negro

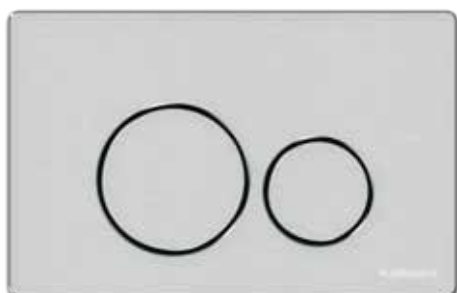

**VANDALÜS PVA-M-CE**

Ref. 0111140001

1 uds/caja

**PVP: 71,90 €**

Acero Inoxidable Mate

**ANTIVANDÁLICO**



**VANDALÜS PVA-B-CE**

Ref. 0111140002

1 uds/caja

**PVP: 91,90 €**

Acero Inoxidable Brillo

**ANTIVANDÁLICO**

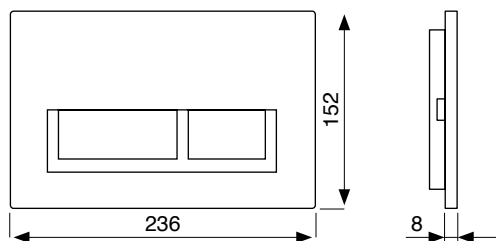

**CIRCÜS PCC-M-CE**  
Ref. 0111120001

1 uds/caja

**PVP: 45,90 €**

Cromo Mate

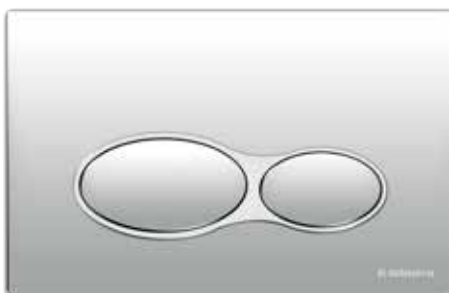

**CIRCÜS PCC-B-CE**  
Ref. 0111120002

1 uds/caja

**PVP: 45,90 €**

Cromo Brillo



**CIRCÜS PCC-N-CE**  
Ref. 0111120003

1 uds/caja

**PVP: 45,90 €**

Negro



**SPARTACÜS PSP-M-CE**  
Ref. 0111150001

1 uds/caja

**PVP: 25,90 €**

Cromo Mate

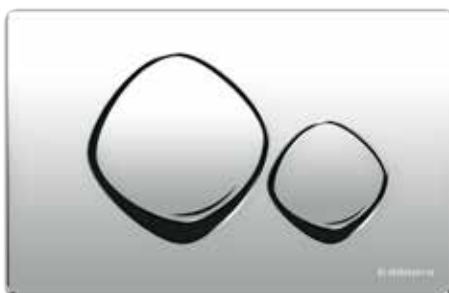

**SPARTACÜS PSP-B-CE**  
Ref. 0111150002

1 uds/caja

**PVP: 25,90 €**

Cromo Brillo

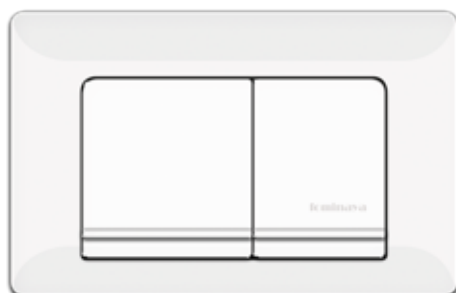

**DOMÜS PDM-BL-CE**  
Ref. 0111160004

1 uds/caja

**PVP: 20,90 €**

Blanco

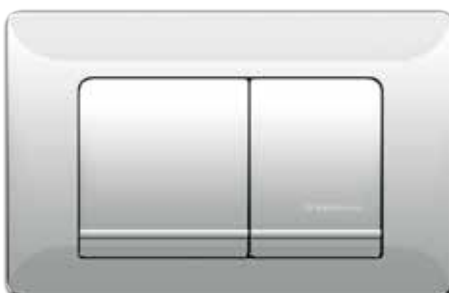

**DOMÜS PDM-CB-CE**  
Ref. 0111160002

1 uds/caja

**PVP: 22,90 €**

Cromo Brillo

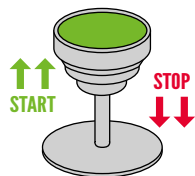

Installation Video



# TIRADOR

## DESCARGADOR UNIVERSAL

Mecanismos universales de tirador.  
No es necesario cortar elementos para su instalación.  
Compatible bases Negra y Fominaya®.



**CE 3**  
Ref. 0146003100  
Packaging Bolsa  
25 uds/caja  
**PVP: 2,85 €**  
Campana  
Especial reposición



**DE 1**  
Ref. 0147004100  
Packaging Bolsa  
20 uds/caja  
**PVP: 4,70 €**  
Campana + Base +  
Kit de Juntas

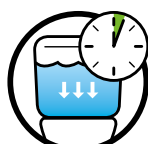

Installation Video



# TIRADOR

## DESCARGADOR UNIVERSAL REGULABLE

Regulación de la descarga: **PRODUCTO VERDE**.  
No es necesario cortar elementos para su instalación.  
Compatible bases Negra y Fominaya®.



**OCEAN DE 2**  
Ref. 0147106300  
Packaging Bolsa  
25 uds/caja  
**PVP: 6,90 €**  
Campana + Base + Acople +  
Kit de Juntas



**BAHYA DE 3**  
Ref. 0147109400  
Packaging Bolsa  
25 uds/caja  
**PVP: 11,25 €**  
Tirador + Campana + Base + Acople +  
Kit de Juntas (especial Victoria)



# TYFON 3G

DESCARGADOR UNIVERSAL INTERRUPTIBLE

Descarga interrumpible: **PRODUCTO VERDE.**  
 No es necesario desmontar la cisterna.  
 Compatible bases Roca\* y Fominaya®.

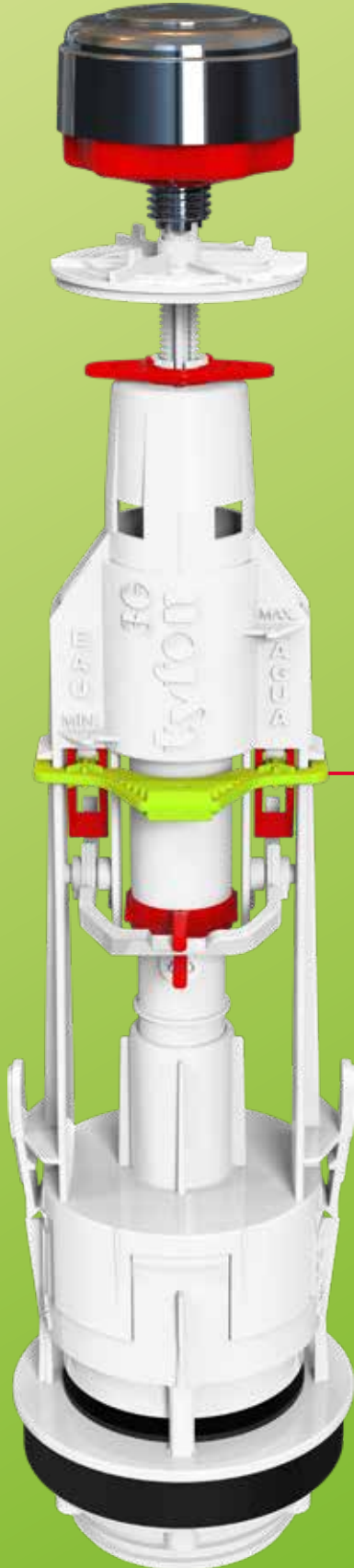

NOVEDAD:  
 SISTEMA DE  
 INSTALACIÓN &  
 TRANSPORTE



Installation Video

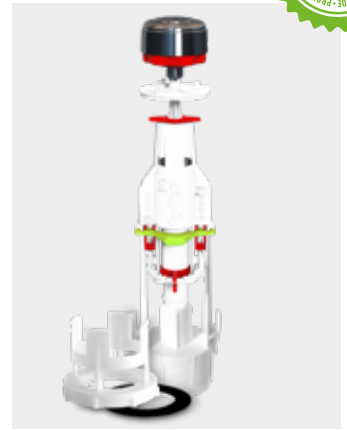

**TYFON 3G 4**  
 Ref. 0129305011  
 Packaging Bolsa  
 25 uds/caja  
**PVP: 10,30 €**  
 Pulsador + Campana + Acople Especial reposición

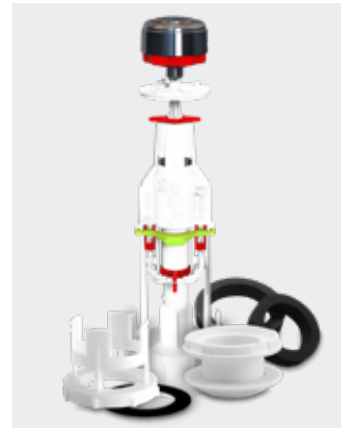

**TYFON 3G 10**  
 Ref. 0129307011  
 Packaging Bolsa  
 25 uds/caja  
**PVP: 12,75 €**  
 Pulsador + Campana + Base + Acople + Kit de Juntas

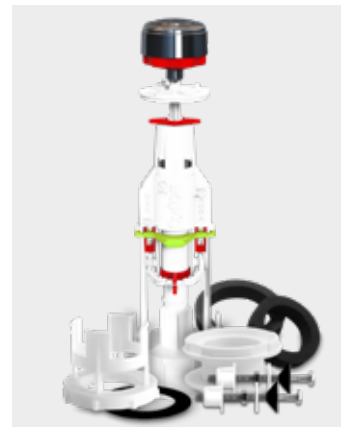

**TYFON 3G 12**  
 Ref. 0129317031  
 Packaging Caja  
 20 uds/caja  
**PVP: 13,40 €**  
 Pulsador + Campana + Base + Acople + Kit de Juntas + Tornillos

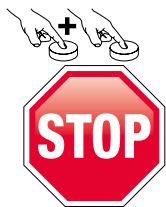

Installation Video

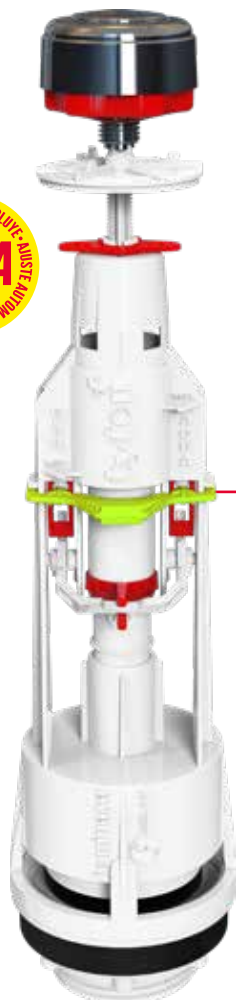

# TYFON+

## DESCARGADOR UNIVERSAL INTERRUPTIBLE

Descarga interrumpible: **PRODUCTO VERDE.**

**NOVEDAD: SISTEMA DE INSTALACIÓN & TRANSPORTE.**

Compatible bases Negra y Fominaya®.



**TYFON+ 5**  
Ref. 0129101031  
Packaging Bolsa

25 uds/caja

**PVP: 10,30 €**

Pulsador + Campana + Base +  
Kit de Juntas

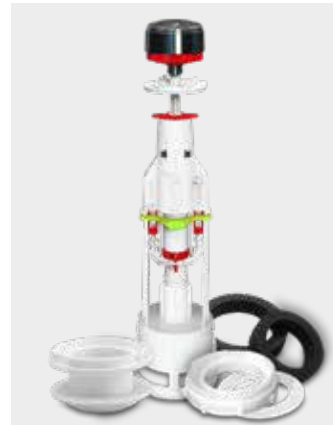

**TYFON+ 10**  
Ref. 0129106031  
Packaging Bolsa

25 uds/caja

**PVP: 11,75 €**

Pulsador + Campana + Base +  
Acople + Kit de Juntas



Installation Video



# CYCLON

## DESCARGADOR UNIVERSAL REGULABLE

Regulación de la descarga: **PRODUCTO VERDE.**

No es necesario cortar elementos para su instalación.

Compatible bases Negra y Fominaya®.



**CYCLON 5**  
Ref. 0129201031  
Packaging Bolsa

25 uds/caja

**PVP: 10,70 €**

Pulsador + Campana + Base +  
Kit de Juntas



**CYCLON 10**  
Ref. 0129206031  
Packaging Bolsa

25 uds/caja

**PVP: 12,15 €**

Pulsador + Campana + Base +  
Acople + Kit de Juntas





# PRÓXIMO LANZAMIENTO

## DESCARGADOR UNIVERSAL REGULABLE

Regulación de la doble descarga: **PRODUCTO VERDE.**

No es necesario desmontar la cisterna.

Compatible bases Roca\* y Fominaya®.



**NOVEDAD:  
SISTEMA DE  
INSTALACIÓN &  
TRANSPORTE**



### ECO TYFON 5G 4

Ref.

Packaging Bolsa

25 uds/caja

**PVP:**

Pulsador + Campana + Acople Especial reposición



### ECO TYFON 5G 10

Ref.

Packaging Bolsa

25 uds/caja

**PVP:**

Pulsador + Campana + Base + Acople + Kit de Juntas



### ECO TYFON 5G 12

Ref.

Packaging Caja

20 uds/caja

**PVP:**

Pulsador + Campana + Base + Acople + Kit de Juntas + Tornillos



9L  
3-4L



Installation Video



# DRACKO

## DESCARGADOR UNIVERSAL CON CABLE

Regulación de la doble descarga: **PRODUCTO VERDE**.  
El cable siempre por encima del agua: anticorrosión.  
Compatible bases Negra, Blanca y Fominaya®.



**DRACKO 12**  
Ref. 0139301011  
Packaging Bolsa

20 uds/caja  
**PVP: 16,00 €**

Pulsador + Campana + Base +  
Acople + Kit de Juntas



**DRACKO 10**  
Ref. 0139307011  
Packaging Caja

20 uds/caja  
**PVP: 16,90 €**

Pulsador + Campana + Base +  
Acople + Kit de Juntas + Tornillos

6-9L  
3-4L



Installation Video



# ECO CYCLON

## DESCARGADOR UNIVERSAL DOBLE REGULACIÓN

Regulación de la doble descarga: **PRODUCTO VERDE**.  
No es necesario cortar elementos para su instalación.  
Compatible bases Negra y Fominaya®.



**ECO CYLON 6**  
Ref. 0139206011  
Packaging Bolsa

25 uds/caja  
**PVP: 18,90 €**

Pulsador + Campana + Base +  
Acople + Kit de Juntas



**ECO CYLON 10**  
Ref. 0139207011  
Packaging Caja

20 uds/caja  
**PVP: 19,90 €**

Pulsador + Campana + Base +  
Acople + Kit de Juntas + Tornillos



# FENYX DUAL

FLOTADOR COMPACTO UNIVERSAL

Lateral + inferior. Boya regulable: **PRODUCTO VERDE**.  
Cierre progresivo pistón: especial todo tipo de aguas.  
Llenado rápido. Sin mantenimiento. Compacto.



Installation Video



**FENYX DUAL**  
Ref. 0144401420  
Packaging Bolsa  
25 uds/caja  
**PVP: 8,90 €**

Ø 3/8" Latón  
Sistema patentado: 201430093



**FENYX DUAL**  
Ref. 0144405420  
Packaging Caja  
12 uds/caja  
**PVP: 9,20 €**

Ø 3/8" Latón  
Sistema patentado: 201430093

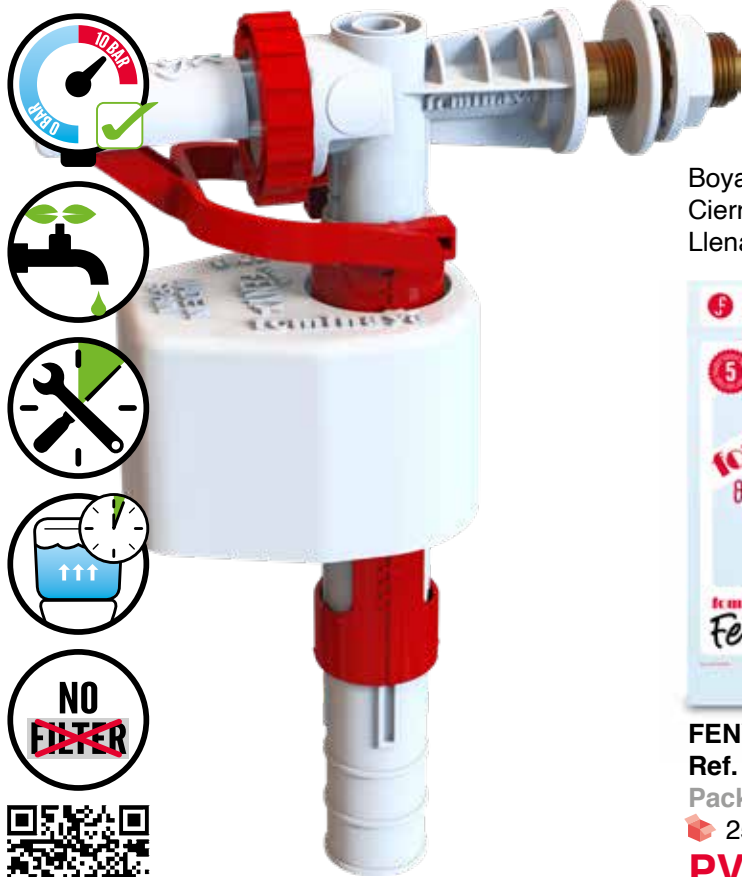

# FENYX L

## FLOTADOR COMPACTO LATERAL

Boya regulable: **PRODUCTO VERDE**.  
 Cierre progresivo pistón: especial todo tipo de aguas.  
 Llenado rápido. Sin mantenimiento. Compacto.



**FENYX L38LB**  
 Ref. 0144180120  
 Packaging Bolsa  
 25 uds/caja  
**PVP: 5,40 €**  
 Ø 3/8" Latón  
 Sistema patentado: 201430093



**FENYX L38L**  
 Ref. 0144160120  
 Packaging Caja  
 16 uds/caja  
**PVP: 6,10 €**  
 Ø 3/8" Latón  
 Sistema patentado: 201430093



# FENYX V

## FLOTADOR COMPACTO INFERIOR

Telescópico. Boya regulable: **PRODUCTO VERDE**.  
 Cierre progresivo pistón: especial todo tipo de aguas.  
 Llenado rápido. Sin mantenimiento. Compacto.



**FENYX V38LB**  
 Ref. 0144380320  
 Packaging Bolsa  
 25 uds/caja  
**PVP: 7,90 €**  
 Ø 3/8" Latón  
 Sistema patentado: 201430093



**FENYX V38L**  
 Ref. 0144360320  
 Packaging Caja  
 16 uds/caja  
**PVP: 8,50 €**  
 Ø 3/8" Latón  
 Sistema patentado: 201430093



Installation Video



Installation Video



# NEMO

## FLOTADOR COMPACTO LATERAL

Boya regulable: **PRODUCTO VERDE**.  
 Muy silencioso. Cierre estanco. Cierre instantáneo.  
 Sistema antirretorno. Compacto.



**NEMO 38L**  
 Ref. 0144191110  
**Packaging Caja**  
 16 uds/caja  
**PVP: 9,60 €**  
 Ø 3/8" Latón  
 Filtro de mantenimiento

# TYTAN

## FLOTADOR COMPACTO INFERIOR

Telescópico. Boya regulable: **PRODUCTO VERDE**.  
 Muy silencioso. Cierre estanco. Cierre instantáneo.  
 Sistema antirretorno. Compacto.



**TYTAN 38L**  
 Ref. 0144391310  
**Packaging Caja**  
 16 uds/caja  
**PVP: 10,65 €**  
 Ø 3/8" Latón  
 Filtro de mantenimiento



Installation Video



# GL 1

## GRIFO FLOTADOR LATERAL

Boya regulable: **PRODUCTO VERDE**.  
Cierre estanco. Cierre progresivo. Sistema antirretorno.  
Resistente a las aguas más duras.



GL 1

Ref. 0144100110

Packaging Bolsa

50 uds/caja

**PVP: 4,50 €**

Ø 3/8" Latón

Boya poliestireno expandido



Installation Video



# GT 1

## GRIFO FLOTADOR INFERIOR

Telescópico. Boya regulable: **PRODUCTO VERDE**.  
Cierre estanco. Cierre progresivo. Sistema antirretorno.  
Resistente a las aguas más duras.



GT 1

Ref. 0144300310

Packaging Bolsa

20 uds/caja

**PVP: 7,15 €**

Ø 3/8" Latón

Boya poliestireno expandido



# TYFON+

DESCARGADOR UNIVERSAL INTERRUPTIBLE

Descarga interrumpible: **PRODUCTO VERDE**.  
 NOVEDAD: SISTEMA REGULACIÓN & TRANSPORTE.  
 Compatible bases Negra y Fominaya®.

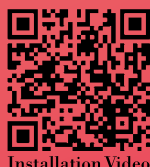
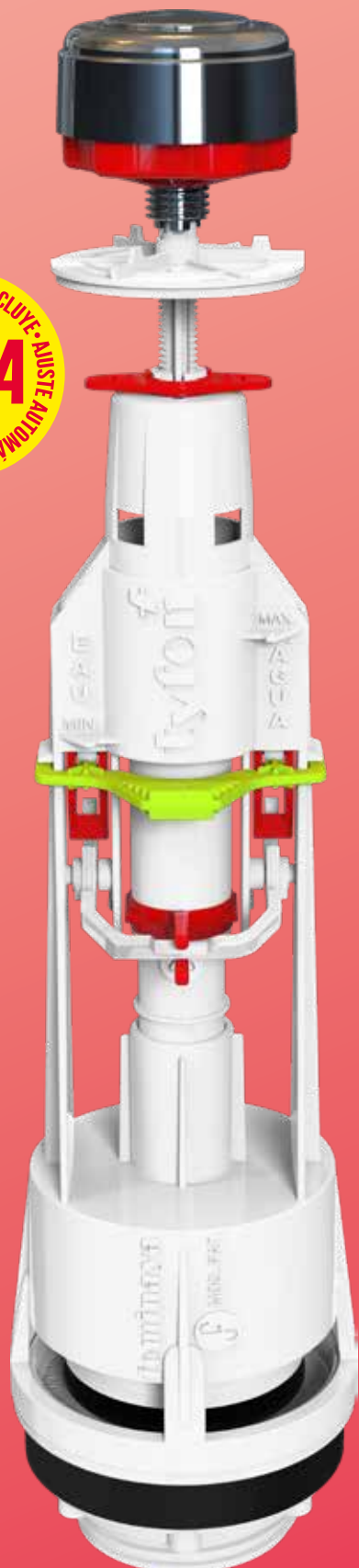

**TYFON+ 3 GL 1**  
 Ref. 0129101231  
 Packaging Bolsa  
 20 uds/caja  
**PVP: 16,90 €**  
 Mecanismo completo Tyfon+ 5 +  
 Grifo Lateral + Tornillos + Embellecedor



**TYFON+ 1 GT 1**  
 Ref. 0129101131  
 Packaging Bolsa  
 20 uds/caja  
**PVP: 18,65 €**  
 Mecanismo completo Tyfon+ 5 +  
 Grifo Inferior + Tornillos + Embellecedor



**TYFON+ 14 FENYXL**  
 Ref. 0129701231  
 Packaging Bolsa  
 15 uds/caja  
**PVP: 18,95 €**  
 Mecanismo completo Tyfon+ 5 +  
 Flotador Lateral + Tornillos + Embellecedor



**TYFON+ 15 FENYXV**  
 Ref. 0129701131  
 Packaging Bolsa  
 15 uds/caja  
**PVP: 20,70 €**  
 Mecanismo completo Tyfon+ 5 +  
 Flotador Inferior + Tornillos



**TYFON+ 7 NEMO**  
 Ref. 0129501231  
 Packaging Bolsa  
 15 uds/caja  
**PVP: 22,00 €**  
 Mecanismo completo Tyfon+ 5 +  
 Flotador Lateral + Tornillos + Embellecedor



**TYFON+ 8 TYTAN**  
 Ref. 0129501131  
 Packaging Bolsa  
 15 uds/caja  
**PVP: 23,30 €**  
 Mecanismo completo Tyfon+ 5 +  
 Flotador Inferior + Tornillos + Embellecedor

# HIDRONEUMÁTICO

## DESCARGADOR CON PULSADOR EMPOTRABLE

Mecanismo accionado por pulsador empotrable.  
Para cisternas de 15 litros.  
La instalación puede quedar oculta.



**DESCARGADOR D 5 M**  
Ref. 0156005020  
Packaging Bolsa  
15 uds/caja  
**PVP: 14,90 €**  
Descargador + Juntas + Grifo GL 1



**CONJUNTO DC 52**  
Ref. 0153004101  
Packaging Bolsa  
10 uds/caja  
**PVP: 29,10 €**  
Descargador + Pulsador PE 5 + Juntas +  
Tubos conexión + Grifo lateral GL 1

Cisterna no incluida



**CISTERNA CQ 3**  
Ref. 0153002101  
Packaging Caja  
1 uds/caja  
**PVP: 37,00 €**  
Cisterna de 15 litros  
Equipamiento: DC 52

## GRIFOS CAZOLETA

Boya regulable: **PRODUCTO VERDE**.  
Cierre estanco. Cierre instantáneo. Sistema antiretorno.  
Resistente a las aguas más duras.



**GC 1**  
Ref. 0151600630  
Packaging Granel  
25 uds/caja  
**PVP: 4,65 €**  
Grifo lateral (Latón) + Tuerca (Plástico)  
Ø 3/8" Latón + Longitud: 30 mm

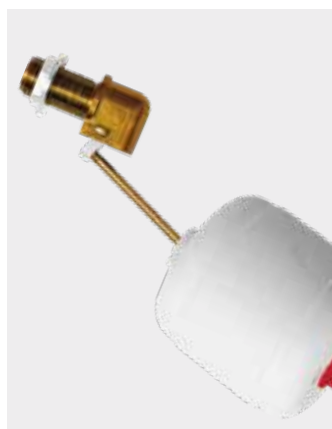

**GCB 1**  
Ref. 0151650630  
Packaging Bolsa  
25 uds/caja  
**PVP: 5,50 €**  
Grifo lateral (Latón) + Tuerca + Boya  
Ø 3/8" Latón + Longitud: 30 mm



**GP 2**  
Ref. 0151501530  
Packaging Granel  
25 uds/caja  
**PVP: 7,25 €**  
Grifo lateral (Latón) + Tuerca (Plástico)  
Ø 3/8" Latón + Longitud: 32 mm

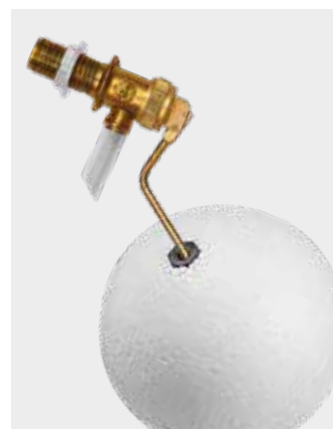

**GPB 2**  
Ref. 0151551530  
Packaging Bolsa  
25 uds/caja  
**PVP: 8,80 €**  
Grifo lateral (Latón) + Tuerca (Plástico) + Boya  
Ø 3/8" Latón + Longitud: 32 mm

## GRIFOS PISTÓN

Cierre estanco. Cierre instantáneo.  
Sistema antiretorno.  
Resistente a las aguas más duras.





**CAMPANA D 07**  
**Ref. 0155002210**  
 Packaging Bolsa  
 25 uds/caja  
**PVP: 2,05 €**  
 Compatible: DC 71 / DC 72  
 Ø 57 mm



**CAMPANA D 25**  
**Ref. 0155003320**  
 Packaging Bolsa  
 25 uds/caja  
**PVP: 1,75 €**  
 Compatible: DC 254  
 Ø 65 mm



**CAMPANA D 025**  
**Ref. 0155003310**  
 Packaging Bolsa  
 25 uds/caja  
**PVP: 3,15 €**  
 Compatible: DC 251 / DC 252  
 Ø 65 mm



**CAMPANA D 026**  
**Ref. 0155004410**  
 Packaging Bolsa  
 25 uds/caja  
**PVP: 1,85 €**  
 Compatible: DC 261 / DC 262  
 Ø 57 mm



**DESCARGADOR DC 62**  
**Ref. 0156001110**  
 Packaging Bolsa  
 25 uds/caja  
**PVP: 8,55 €**  
 Ø 5 mm + Longitud: 165 mm (Latón)  
 Base: Zamak-5 (Metal)

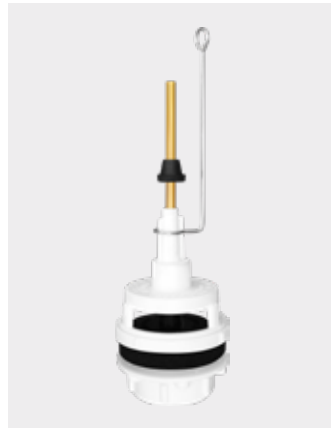

**DESCARGADOR DC 71**  
**Ref. 0156002210**  
 Packaging Bolsa  
 25 uds/caja  
**PVP: 3,30 €**  
 Ø 7 mm + Longitud: 165 mm (Latón)  
 Base: PS/SBR (Plástico)



**DESCARGADOR DC 72**  
**Ref. 0156002310**  
 Packaging Bolsa  
 25 uds/caja  
**PVP: 7,40 €**  
 Ø 7 mm + Longitud: 165 mm (Latón)  
 Base: Zamak-5 (Metal)

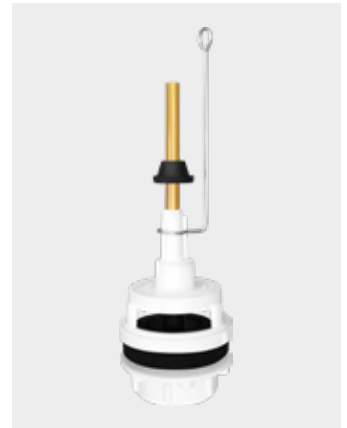

**DESCARGADOR DC 251**  
**Ref. 0156003510**  
 Packaging Bolsa  
 25 uds/caja  
**PVP: 4,45 €**  
 Ø 12 mm + Longitud: 175 mm (Latón)  
 Base: PS/SBR (Plástico)



**DESCARGADOR DC 252**  
**Ref. 0156003610**  
 Packaging Bolsa  
 25 uds/caja  
**PVP: 8,55 €**  
 Ø 12 mm + Longitud: 175 mm (Latón)  
 Base: Zamak-5 (Metal)



**DESCARGADOR DC 254**  
**Ref. 0156003720**  
 Packaging Bolsa  
 25 uds/caja  
**PVP: 3,10 €**  
 Ø 12 mm + Longitud: 175 mm (Plástico)  
 Base: PS/SBR (Plástico)

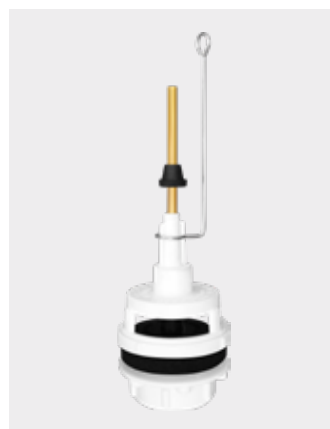

**DESCARGADOR DC 261**  
**Ref. 0156004810**  
 Packaging Bolsa  
 25 uds/caja  
**PVP: 3,05 €**  
 Ø 5 mm + Longitud: 165 mm (Latón)  
 Base: PS/SBR (Plástico)



**DESCARGADOR DC 262**  
**Ref. 0156004910**  
 Packaging Bolsa  
 25 uds/caja  
**PVP: 7,20 €**  
 Ø 5 mm + Longitud: 165 mm (Latón)  
 Base: Zamak-5 (Metal)

## BOLSAS EQUIPADAS CISTERNA ALTA

Contiene: Descargador + Juntas + Cadenilla/Tirador + Grifo 3/8" Latón con Varilla y Boya + Palanca + Tornillos + Tacos + Escarpías



### CISTERNA EQUIPADA CQ 2

Ref. 0153002608

Packaging Bolsa

8 uds/caja

**PVP: 22,00 €**

Capacidad: 15 litros

Equipamiento: BL254



### BOLSA EQUIP. BL 72

Ref. 0153004604

Packaging Bolsa

20 uds/caja

**PVP: 16,60 €**

Grifo: GC 1

Descargador: DC 72



### BOLSA EQUIP. BL 072

Ref. 0153004504

Packaging Bolsa

20 uds/caja

**PVP: 20,00 €**

Grifo: GP 2

Descargador: DC 72



### BOLSA EQUIP. BL 252

Ref. 0153004607

Packaging Bolsa

20 uds/caja

**PVP: 17,75 €**

Grifo: GC 1

Descargador: DC 252



### BOLSA EQUIP. BL 263

Ref. 0153014110

Packaging Bolsa

20 uds/caja

**PVP: 14,90 €**

Grifo: GL 1

Descargador: DC 262



### BOLSA EQUIP. BL 254

Ref. 0153004608

Packaging Bolsa

20 uds/caja

**PVP: 12,30 €**

Grifo: GC 1

Descargador: DC 254



### BOLSA EQUIP. BL 261

Ref. 0153004609

Packaging Bolsa

20 uds/caja

**PVP: 12,30 €**

Grifo: GC 1

Descargador: DC 261



### BOLSA EQUIP. BL 262

Ref. 0153004610

Packaging Bolsa

20 uds/caja

**PVP: 16,50 €**

Grifo: GC 1

Descargador: DC 262



### BOLSA EQUIP. BL 062

Ref. 0153004602

Packaging Bolsa

20 uds/caja

**PVP: 17,50 €**

Grifo: GC 1

Descargador: DC 62



**Manguito MX DÚO**  
 Ref. 0138543020  
 Packaging Bolsa  
 15 uds/caja  
**PVP: 4,50 €**  
 Excéntrico Ø 90 / 110 mm



**Manguito M 9**  
 Ref. 0138043010  
 Granel  
 36 uds/caja  
**PVP: 4,35 €**  
 Recto Ø 90 mm

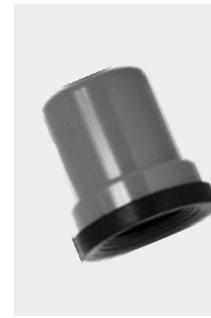

**Manguito M 11**  
 Ref. 0138043020  
 Granel  
 36 uds/caja  
**PVP: 4,50 €**  
 Recto Ø 110 mm



**Manguito MX 9**  
 Ref. 0138043030  
 Granel  
 36 uds/caja  
**PVP: 4,35 €**  
 Excéntrico Ø 90 mm



**Cisterna C 2**  
 Ref. 0153002011  
 Packaging Bolsa  
 8 uds/caja  
**PVP: 10,25 €**  
 Capacidad: 15 litros



**Manguito MX 11**  
 Ref. 0138043040  
 Granel  
 36 uds/caja  
**PVP: 4,50 €**  
 Excéntrico Ø 110 mm



**Junta CM 1**  
 Ref. 0138048070  
 Granel  
 36 uds/caja  
**PVP: 1,00 €**  
 Ø 90 / 110 mm



**Junta CM 2**  
 Ref. 0138048090  
 Granel  
 36 uds/caja  
**PVP: 1,40 €**  
 Standard



**Tornillos TP 1**  
 Ref. 0154564010  
 Granel  
 100 uds/caja  
**PVP: 0,25 €**  
 Hierro Galvanizado



**Kit Tornillos TP 2**  
 Ref. 0154564030  
 Packaging Bolsa  
 50 uds/caja  
**PVP: 0,70 €**  
 Tornillos + Tacos + Escarpías



**Bajante BI 1**  
 Ref. 0154067010  
 Packaging Caja  
 10 uds/caja  
**PVP: 7,00 €**  
 Altura: 175 mm Ø 32 mm

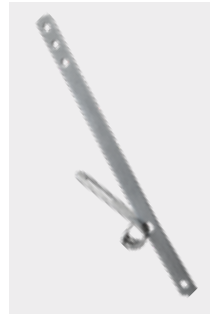

**Palanca PA 25**  
 Ref. 0154007010  
 Granel  
 25 uds/caja  
**PVP: 0,85 €**  
 Longitud: 250 mm

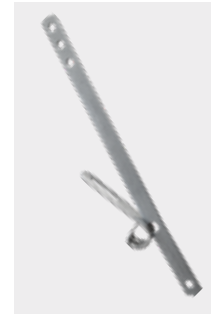

**Palanca PA 27**  
 Ref. 0154007020  
 Granel  
 25 uds/caja  
**PVP: 0,85 €**  
 Longitud: 275 mm

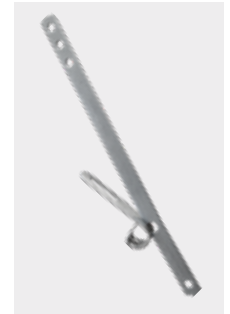

**Palanca PA 30**  
 Ref. 0154007030  
 Granel  
 25 uds/caja  
**PVP: 0,85 €**  
 Longitud: 300 mm



**Tapa WC TA 1**  
 Ref. 0153600010  
 Packaging Bolsa  
 12 uds/caja  
**PVP: 12,25 €**  
 Polipropileno (Incluye tornillos)



**Tapa WC TA 2**  
 Ref. 0153600020  
 Packaging Caja  
 10 uds/caja  
**PVP: 28,60 €**  
 ABS (Incluye tornillos)

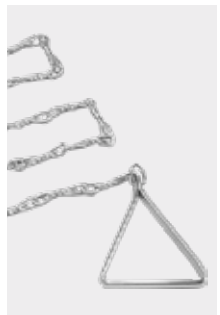

**Cadenilla CA 1**  
 Ref. 0154005010  
 Packaging Bolsa  
 25 uds/caja  
**PVP: 2,65 €**  
 Hierro Galvanizado



**Enchufe EG 3**  
 Ref. 0154043010  
 Granel  
 25 uds/caja  
**PVP: 1,20 €**  
 Compatible: Peninsular



**Enchufe EG 1**  
 Ref. 0154043020  
 Granel  
 25 uds/caja  
**PVP: 1,35 €**  
 Compatible: Lucerna



**Enchufe EG 2**  
 Ref. 0154043030  
 Granel  
 25 uds/caja  
**PVP: 1,40 €**  
 Compatible: Victoria

**CISTERNA BAJA RECAMBIOS**



**Campana CF 2**  
 Ref. 0146007200  
 Packaging Bolsa  
 25 uds/caja  
**PVP: 2,85 €**  
 Standard



**Descargador DF 2**  
 Ref. 0147003200  
 Packaging Bolsa  
 50 uds/caja  
**PVP: 4,35 €**  
 Ganchillo: 195 mm



**Descargador DF 3**  
 Ref. 0147008200  
 Packaging Bolsa  
 50 uds/caja  
**PVP: 4,35 €**  
 Ganchillo: 175 mm



**Campana CE 4**  
 Ref. 0146104300  
 Packaging Bolsa  
 20 uds/caja  
**PVP: 5,00 €**  
 Campana invertida standard



**CF 1**  
 Ref. 0146105400  
 Packaging Bolsa  
 25 uds/caja  
**PVP: 9,20 €**  
 Especial Victoria



**Boya BY 7**  
 Ref. 0144701740  
 Granel  
 25 uds/caja  
**PVP: 0,85 €**  
 Poliestireno expandido



**Acople AD 1**  
 Ref. 0138529010  
 Granel  
 25 uds/caja  
**PVP: 1,40 €**  
 Adaptador Roca-Gala\*



**Acople AD 2**  
 Ref. 0138529020  
 Granel  
 25 uds/caja  
**PVP: 1,40 €**  
 Adaptador Roca-Gala\*



**Acople AD 3**  
 Ref. 0138529030  
 Granel  
 25 uds/caja  
**PVP: 1,40 €**  
 Adaptador Roca-Gala\*



**Base BT 1**  
 Ref. 0138508010  
 Granel  
 25 uds/caja  
**PVP: 0,95 €**  
 Base + Tuerca Fominaya®

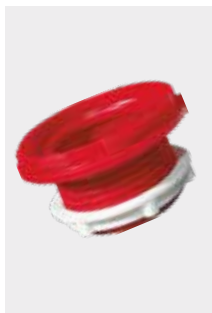

**Base BT 2**  
 Ref. 0138508020  
 Granel  
 25 uds/caja  
**PVP: 0,95 €**  
 Base + Tuerca Fominaya®



**Base BT 3**  
 Ref. 0138508030  
 Granel  
 25 uds/caja  
**PVP: 1,40 €**  
 Base + Tuerca Dracko + Tyfon 3G



**Pulsador PTY 1**  
 Ref. 0142303110  
 Packaging Bolsa  
 25 uds/caja  
**PVP: 2,95 €**  
 Pulsador Tyfon + Cyclon

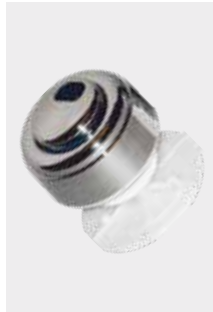

**Pulsador P 1**  
 Ref. 0142203110  
 Packaging Bolsa  
 25 uds/caja  
**PVP: 5,55 €**  
 Pulsador Eco Cyclon

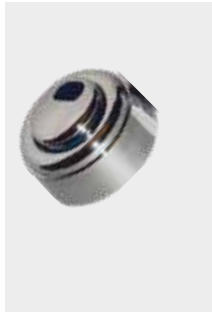

**Pulsador PDK 1**  
 Ref. 0142204110  
 Packaging Bolsa  
 25 uds/caja  
**PVP: 5,55 €**  
 Pulsador Dracko



**Manivela PC 2**  
 Ref. 0142015130  
 Packaging Bolsa  
 10 uds/caja  
**PVP: 13,70 €**  
 Especial Roca / 280 mm

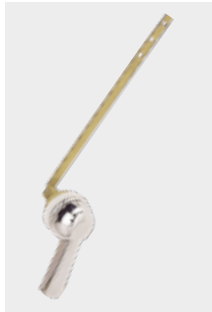

**Manivela PM 1**  
 Ref. 0142018130  
 Packaging Bolsa  
 10 uds/caja  
**PVP: 10,95 €**  
 Especial Roca / 170 mm

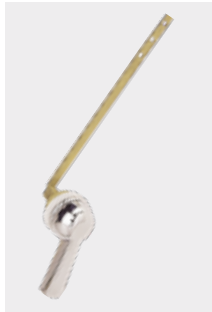

**Manivela PM 2**  
 Ref. 0142019130  
 Packaging Bolsa  
 10 uds/caja  
**PVP: 11,05 €**  
 Concreto / 230 mm



**Embellecedor TP C**  
 Ref. 0138015010  
 Granel  
 25 uds/caja  
**PVP: 0,65 €**  
 Tapón Lateral ABS Cromado



**Embellecedor TP P**  
 Ref. 0138015070  
 Granel  
 25 uds/caja  
**PVP: 0,30 €**  
 Tapón Lateral Polipropileno



**Tirador TV 1 C**  
 Ref. 0142001110  
 Packaging Bolsa  
 25 uds/caja  
**PVP: 2,05 €**  
 ABS Cromado: 83 mm



**Tirador TV 1 A**  
 Ref. 0142001120  
 Packaging Bolsa  
 25 uds/caja  
**PVP: 3,75 €**  
 Latón Cromado: 83 mm



**Tirador TV 5 C**  
 Ref. 0142005110  
 Packaging Bolsa  
 25 uds/caja  
**PVP: 2,30 €**  
 ABS Cromado: 114 mm



**Tirador TV 5 A**  
 Ref. 0142005120  
 Packaging Bolsa  
 25 uds/caja  
**PVP: 3,95 €**  
 Latón Cromado: 114 mm



**Tirador TV 6 C**  
 Ref. 0142006110  
 Packaging Bolsa  
 25 uds/caja  
**PVP: 1,95 €**  
 ABS Cromado: 88 mm



**Tirador TV 6 A**  
 Ref. 0142006120  
 Packaging Bolsa  
 25 uds/caja  
**PVP: 3,65 €**  
 Latón Cromado: 88 mm



**Tirador TV 4 C**  
 Ref. 0142004110  
 Packaging Bolsa  
 25 uds/caja  
**PVP: 2,05 €**  
 ABS Cromado: 114 mm



**Tirador TV 4 A**  
 Ref. 0142004120  
 Packaging Bolsa  
 25 uds/caja  
**PVP: 3,70 €**  
 Latón Cromado: 114 mm



**Embellecedor TPI**  
 Ref. 0138015030  
 Granel  
 25 uds/caja  
**PVP: 0,60 €**  
 Tapón Inferior Resina



**Embellecedor EM 1**  
 Ref. 0138015040  
 Granel  
 50 uds/caja  
**PVP: 0,40 €**  
 Embellecedor Lavabo / Bidé



**Obturadora RF 1**  
 Ref. 0138003030  
 Granel  
 100 uds/caja  
**PVP: 0,65 €**  
 Ø 68 x 18 mm



**Obturadora RF 2**  
 Ref. 0138003040  
 Granel  
 100 uds/caja  
**PVP: 0,55 €**  
 Ø 68 x 18 mm



**Obturadora RB 1**  
 Ref. 0138003010  
 Granel  
 100 uds/caja  
**PVP: 0,45 €**  
 Ø 56 x 18 mm



**Obturadora RB 2**  
 Ref. 0138003020  
 Granel  
 100 uds/caja  
**PVP: 0,55 €**  
 Ø 73 x 23 mm Especial Roca



**Obturadora RB 4**  
 Ref. 0138003080  
 Granel  
 100 uds/caja  
**PVP: 0,60 €**  
 Ø 65 x 17 mm Fominaya®



**Obturadora RB 5**  
 Ref. 0138003090  
 Granel  
 100 uds/caja  
**PVP: 0,50 €**  
 Ø 62 x 17 mm Fominaya®

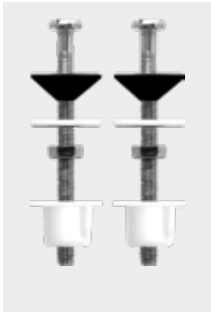

**Tornillos TC 1**  
 Ref. 0140564030  
 Packaging Bolsa  
 25 uds/caja  
**PVP: 1,85 €**  
 Cisterna / WC RM 6 x 80 mm

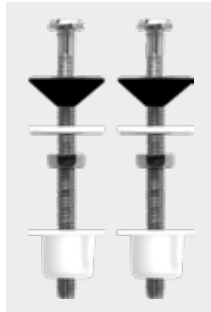

**Tornillos TC 2**  
 Ref. 0140564040  
 Packaging Bolsa  
 25 uds/caja  
**PVP: 2,10 €**  
 Cisterna / WC RM 6 x 120 mm



**Tornillos TI 1**  
 Ref. 0140564050  
 Packaging Bolsa  
 25 uds/caja  
**PVP: 0,70 €**  
 Inodoro / Bidé Vertical



**Tornillos TI 2**  
 Ref. 0140564060  
 Packaging Bolsa  
 25 uds/caja  
**PVP: 1,70 €**  
 Inodoro / Bidé Horizontal



**Tornillos TI 5**  
 Ref. 0140564080  
 Packaging Bolsa  
 25 uds/caja  
**PVP: 6,10 €**  
 Inodoro / Bidé Horizontal



**Tornillos TL 1**  
 Ref. 0138564010  
 Packaging Bolsa  
 25 uds/caja  
**PVP: 1,70 €**  
 Lavabo



**Junta JI 1**  
 Ref. 0138048040  
 Granel  
 50 uds/caja  
**PVP: 0,95 €**  
 Ø 105 x 85 x 10 mm



**Junta JI 3**  
 Ref. 0138048010  
 Granel  
 50 uds/caja  
**PVP: 1,50 €**  
 Ø 100 x 59 mm



**Junta JI 5**  
 Ref. 0138048030  
 Granel  
 50 uds/caja  
**PVP: 1,65 €**  
 Ø 110 x 58 mm

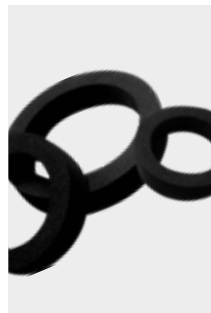

**Kit Juntas KJ 1**  
 Ref. 0138548010  
 Granel  
 50 uds/caja  
**PVP: 1,90 €**  
 Ø 111 / 82 / 56 mm x 20 Espesor



**Kit Juntas KJ 2**  
 Ref. 0138548020  
 Granel  
 50 uds/caja  
**PVP: 1,60 €**  
 Ø 111 / 82 / 56 mm x 15 Espesor

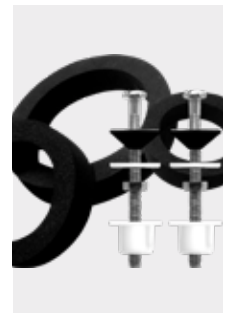

**Kit Juntas KJT 1**  
 Ref. 0138576010  
 Packaging Bolsa  
 10 uds/caja  
**PVP: 3,20 €**  
 Ø 111 / 82 / 56 mm x 15 Espesor

**CISTERNA EMPOTRADA RECAMBIOS**



**Descargador DE 4**  
**Ref. 0110701010**  
 Packaging Bolsa  
 1 uds/caja  
**PVP: 15,45 €**  
 Compatible: Sena + Nilo + Volga



**Descargador DE 5**  
**Ref. 0110702010**  
 Packaging Bolsa  
 1 uds/caja  
**PVP: 20,60 €**  
 Compatible: Nilo CE + Volga CE



**Descargador DE 6**  
**Ref. 0110703010**  
 Packaging Bolsa  
 1 uds/caja  
**PVP: 20,60 €**  
 Compatible: Alba CE



**Grifo GL 7**  
**Ref. 0110180120**  
 Packaging Bolsa  
 1 uds/caja  
**PVP: 10,30 €**  
 Compatible: Sena + Nilo + Volga  
 Ø 1/2" POM



**Grifo GL 8**  
**Ref. 0110181120**  
 Packaging Bolsa  
 1 uds/caja  
**PVP: 30,90 €**  
 Compatible: Alba CE  
 Ø 3/8" POM



**Grifo GL 9**  
**Ref. 0110182120**  
 Packaging Bolsa  
 1 uds/caja  
**PVP: 30,90 €**  
 Compatible: Nilo CE + Volga CE  
 Ø 3/8" POM

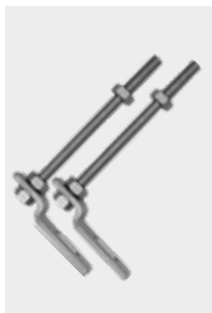

**Tornillos TSP 1**  
**Ref. 0111564029**  
 Packaging Bolsa  
 1 uds/caja  
**PVP: 14,95 €**  
 Compatible: Nilo CE



**Tornillos TSP 2**  
**Ref. 0111564049**  
 Packaging Bolsa  
 1 uds/caja  
**PVP: 14,95 €**  
 Compatible: Alba CE

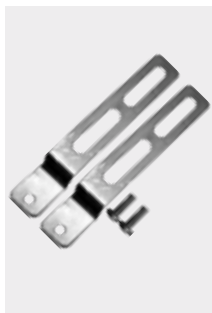

**Tornillos TSP 3**  
**Ref. 0111564059**  
 Packaging Bolsa  
 1 uds/caja  
**PVP: 14,00 €**  
 Compatible: Volga CE



**Placa PSA**  
**Ref. 0111076019**  
 Packaging Bolsa  
 1 uds/caja  
**PVP: 13,40 €**  
 Compatible: Sena + Nilo + Volga



**Soporte SMA 12**  
**Ref. 0111076029**  
 Packaging Bolsa  
 1 uds/caja  
**PVP: 10,30 €**  
 Compatible: Nilo CE



**Soporte SMA 8**  
**Ref. 0111076059**  
 Packaging Bolsa  
 1 uds/caja  
**PVP: 10,30 €**  
 Compatible: Alba CE



**Codo CDI 1**  
**Ref. 0111527049**  
 Packaging Bolsa  
 1 uds/caja  
**PVP: 15,45 €**  
 Compatible: Sena + Nilo + Volga  
 Ø 90/110 mm



**Codo CDI 2**  
**Ref. 0111527069**  
 Packaging Bolsa  
 1 uds/caja  
**PVP: 16,50 €**  
 Compatible: Sena + Nilo + Volga  
 Ø 110 mm



**Codo CDI 3**  
**Ref. 0111527089**  
 Packaging Bolsa  
 1 uds/caja  
**PVP: 16,50 €**  
 Compatible: Alba CE



**Conexión CSA 1**  
**Ref. 0111527059**  
 Packaging Bolsa  
 1 uds/caja  
**PVP: 6,20 €**  
 Compatible: Todos



**Conexión CSA 2**  
**Ref. 0111527079**  
 Packaging Bolsa  
 1 uds/caja  
**PVP: 6,20 €**  
 Compatible: Todos



**Codo CDB**  
**Ref. 0111527029**  
 Packaging Bolsa  
 1 uds/caja  
**PVP: 5,15 €**  
 Compatible: Bidé + Lavabo Nilo

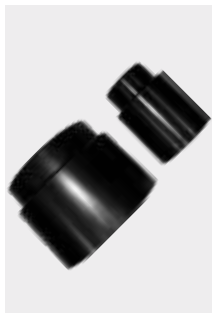

**Tapones TP B**  
**Ref. 0111063019**  
 Packaging Bolsa  
 1 uds/caja  
**PVP: 7,20 €**  
 Compatible: Todos



**Llave LLR**  
**Ref. 0111600019**  
 Packaging Bolsa  
 1 uds/caja  
**PVP: 15,45 €**  
 Compatible: Todos



**Tornillos TI 3**  
**Ref. 0111564019**  
 Packaging Bolsa  
 1 uds/caja  
**PVP: 10,30 €**  
 Compatible: Nilo + Alba CE



**Tornillos TI 4**  
**Ref. 0111564039**  
 Packaging Bolsa  
 1 uds/caja  
**PVP: 8,25 €**  
 Compatible: Lavabo Nilo



**Anillo Cierre ACB**  
**Ref. 0111012010**  
 Packaging Bolsa  
 1 uds/caja  
**PVP: 1,55 €**  
 Compatible: Todos



**Codo CL 12**  
**Ref. 0111527019**  
 Packaging Bolsa  
 1 uds/caja  
**PVP: 20,60 €**  
 Compatible: Bidé + Lavabo Nilo

# fominaya®

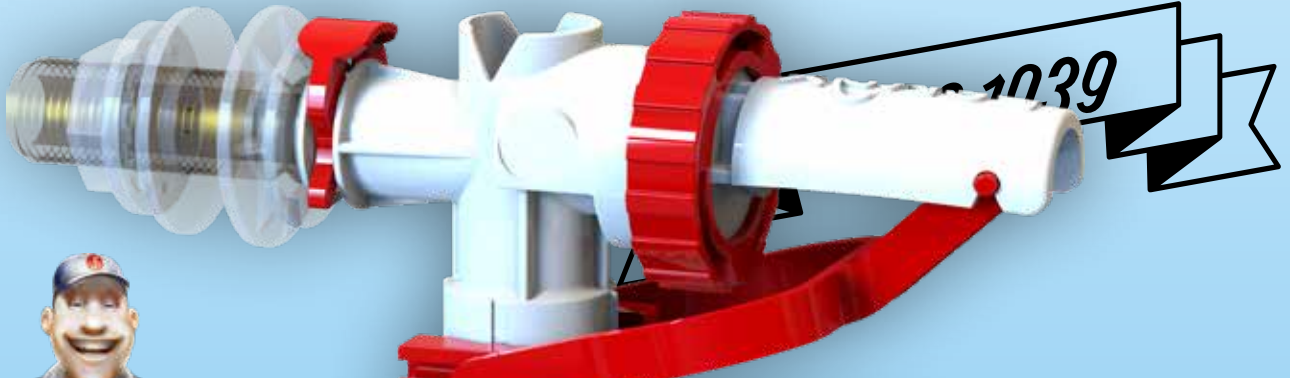

*Lateral+  
Inferior*

**FLOTADOR COMPACTO  
CON BOYA REGULABLE**

**FENYX**  
*Dual*



**AHORRO DE AGUA:  
100% REGULABLE**



**AHORRO DE AGUA:  
LLENADO RÁPIDO**



**5 MINUTOS:  
MUY FÁCIL INSTALACIÓN**



**SILENCIOSO: CIERRE  
PISTÓN PROGRESIVO**

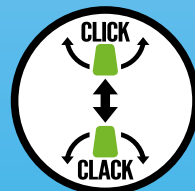

**CLICK CLACK: SISTEMA  
PATENTADO 201430093**



**NO NECESITA  
MANTENIMIENTO**

**100% NACIONAL**

**fominaya**<sup>®</sup>  
*Original* *Since 1939*



Ctra. del Pla, s/n • Apdo. Correos, 62  
46117 Bétera • Valencia • Spain  
N° 39,59831 • W° 0,45501  
T. +34 961 600 651 • F. +34 961 601 351  
[correo@fominaya.com](mailto:correo@fominaya.com)  
[www.fominaya.com](http://www.fominaya.com)

