

ISLENVAS

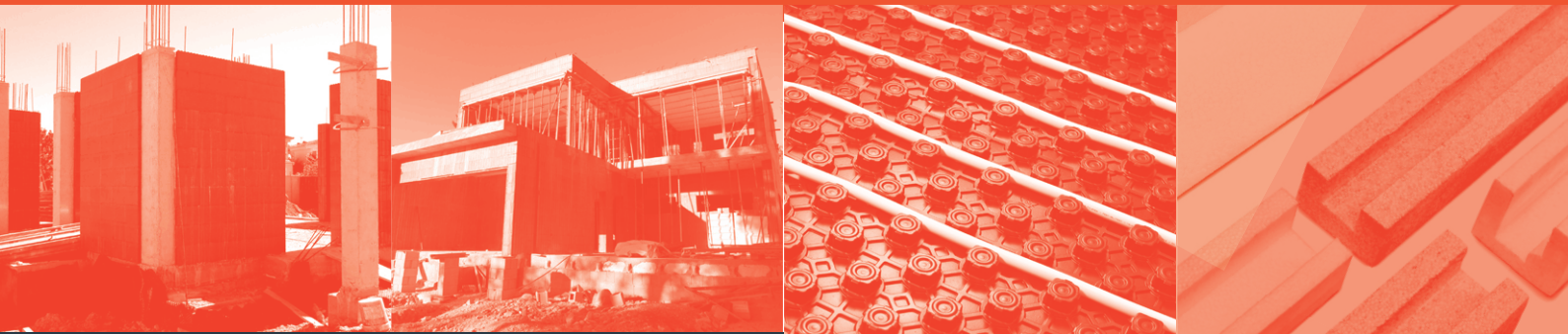





DÉCADAS DE HISTORIA

RA

-
-
-
-

Placas
plásticas para cornisas.

-
-
-
-

Poliradiante: las placas moldeadas y plastificadas para

-
-
-

-
-
-

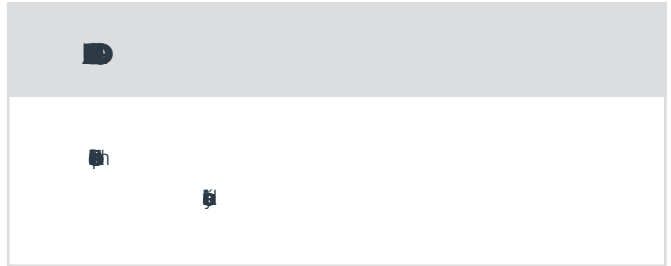

■

de una flota propia de transporte, así como de un exigente

-
-
-
-
-

AISLAMIENTOS Y COMPLEMENTOS PARA LA CONSTRUCCIÓN

Neo^{en}	6
Neo^g	7
Sate^a	9
Frontal forjado^a	0
EPS^a	1
Forjalipor^b	2
Cubierta^a	3
Green^p	3
XPS^g	3
Cornixpor^b	4
TBT^v	6
Gran^b	8
Complementos	0

AISLAMIENTOS PARA SUELO RADIANTE

Poli^g	0
Poli^g Plus	2
Neo^g	2
Neo^g Plus	2
Poli^g Impacto^o	8
Poli^g Impacto^o Plus	8

SISTEMAS ESTRUCTURALES

Silver^b	0
Poliblock^m	3
Tecob^r	3
Poli^b	6

EMBALAJE Y APLICACIONES INDUSTRIALES

EPS - ^{fn}	8
EPS - ^h	4
EPS - ^g	4
EPS - ^{hn}	2

Neob[®]

Neob[®]

Sate[®]

Frontal forjado[®]

EPS[®]

Forjalipor[®]

Cubierta[®]

Green[®]

XPS[®]

Cornixpor[®]

TBT[®]

Gran[®]

Complementos

AISLAMIENTOS Y COMPLEMENTOS PARA LA CONSTRUCCIÓN



SEIS OBRAS



Neotm®



Neotermic® Grafito CR 

	λ/W	h	h ₁ m	R (m ² /W)	q	h ²	h ³
	0	0 x 0	0	0	6		
			0	3	2		
			0	0	0		
			0	0	8		
			0	0	7		
			0	3	6		
			0	0	5		
			0	0	5		
			0	0	4		
	0	0 x 0	0	0	6		
			0	3	2		
			0	0	0		
			0	0	8		
			0	0	7		
			0	3	6		
			0	0	5		
			0	0	5		
			0	0	4		

Neotermic® Grafito BT 

	λ/W	h	h ₁ m	R (m ² /W)	q	h ²	h ³
	0	0 x 0	0	3	2		
			0	0	0		
			0	0	8		
			0	3	6		
			0	0	5		
			0	0	4		

Neotermic® Grafito SF 

	λ/W	h	h ₁ m	R (m ² /W)	q	h ²	h ³
	0	0 x 0	0	3	2		
			0	0	0		
			0	0	8		
			0	3	6		
			0	0	5		

Neo®



Neoacoustic® IMPACTO 🇪🇸



	α	λ ₁₀₀	h	h ₁	α ₁ 2 _h	α	h ₁ 2
	0.9	0	0 x 0	0	0	0	
	0.9			5	0	0	
	0.9			0	0	0	

Neoacoustic® IMPACTO 🇪🇸





	α	λ ₁₀₀	h	h ₁	α ₁ 2 _h	α	h ₁ 2
	0.9	0	0 x 0	0	0	5	
	0.9			5	0	8	
	0.9			0	0	2	
	0.9	0	0 x 0	0	0	0	

Neoacoustic® IMPACTO Plus 🇪🇸



	α	λ ₁₀₀	h	h ₁	α ₁ 2 _h	α	h ₁ 2
	0.9	0	0 x 0	8	0	7	

Neoacoustic® TIRAS 

	λ	h	A	g	R	U	h ²
cm	m	m	m	m	(m ² /K)	m	m ²
	0	0	0	0	0	0	0
			0				
			0				
			0				
			0				
	0	0	0	0	0	0	0
			0				
			0				
			0				
			0				

Neoacoustic® CR 

	λ	h	A	R	U	h ²	
cm	m	m	m	(m ² /K)	m	m ²	
	0	0 x 0	0	0	0	0	0
			0				
			0				
			0				
			0				
			0				
			0				

Neoacoustic® Medianera 

	λ	h	A	R	U	h ²	
cm	m	m	m	(m ² /K)	m	m ²	
	0	0 x 0	0	0	0	0	0



📏	λ [W]	\bar{h} [m]	R (m^2 W)	\bar{h} [m]	R [m ² W]	\bar{h} [m]	R (m^2 W)	📏 ²	📏 ³
📏	0	0	0	0	7	0			
📏		0	0	0	7	3			
📏		0	0	0	7	0			
📏		0	0	0	7	8			
📏		0	0	2	7	6			
📏		0	0	0	7	5			
📏		0	0	0	7	5			
📏		0	0	8	7	4			
📏		0	0	8	7	4			
📏		0	0	6	7	3			
📏		0	0	6	7	3			
📏		0	0	6	7	3			
📏		0	0	4	7	2			



📏	λ [W]	\bar{h} [m]	R (m^2 W)	\bar{h} [m]	R [m ² W]	\bar{h} [m]	R (m^2 W)	📏 ²	📏 ³
📏	0	0	0	0	7	0			
📏		0	0	0	7	3			
📏		0	0	0	7	0			
📏		0	0	0	7	8			
📏		0	0	2	7	6			
📏		0	0	0	7	5			
📏		0	0	0	7	5			
📏		0	0	8	7	4			
📏		0	0	8	7	4			
📏		0	0	6	7	3			
📏		0	0	6	7	3			
📏		0	0	6	7	3			
📏		0	0	4	7	2			



Frontal forjado

Frontal forjado · Aislenvas

	λ/W	ϕ m	ε m	δ m	R (m ² ·K/W)	ϕ g	ln g	ln	
	0	0	0	0	0	2	6		
				0	0	2	8		
				6	2	0	0		
			6	0	0	2	6		
				0	0	2	8		
				6	2	0	0		

5)

Frontal forjado NEO · Aislenvas

	λ/W	ϕ m	ε m	δ m	R (m ² ·K/W)	ϕ g	ln g	ln	
	0	0	0	0	0	2	6		
				0	0	2	8		
				6	0	0	0		
			6	0	0	2	6		
				0	0	2	8		
				6	0	0	0		

5)



EPS



EPS · Aislervas 



■	λ [m]	■	m ³	m ³	■ 2	■ 3
■	0	2	0	0		
	0	6	0	2		
	0	2	0	2		
	0	0	0	0		
■	0	2	0	0		
	0	6	0	2		
	0	2	0	2		
	0	0	0	0		

EPS · Aislervas 



















■	λ [m]	R (m ² /W)	■	m ³	m ³	■ 2	■ 3
■	0	0	2	0	2		
		2	0	0	0		
■	0	0	2	0	0		
		0	6	0	2		
		0	2	0	2		
		0	0	0	0		
■	0	0	2	0	0		
		0	6	0	2		
		0	2	0	2		
		0	0	0	0		
■	0	0	2	0	0		
		0	6	0	2		
		0	2	0	2		
		0	0	0	0		









Forjalipor













Forjalipor · Bovedillas

					3	
	 	0 x 0		0 0 0 0 0		
	 	0 x 0		0 0 0 0		
	 	0 x 0		0 0 0 0		

Forjalipor · Bovedillas

					3	
	 	0 x 0		0 0 0 0		

Forjalipor · Bovedillas

					3	
		0 x 0		0 0 0 0		
		0 x 0		0 0 0 0		

Cubierta



Cubierta · Aislenvas

	λ	h	R	h	h
	0,035	100	0,35	0,35	0,35
			0,70	0,70	0,70
	0,035	100	0,70	0,70	0,70
			1,05	1,05	1,05

📄

Greenp[®]



Greenpol[®] PLUS Cubierta invertida

	λ	h	R	R	h	h
	0,035	100	0,35	0,35	0,35	0,35
				0,70	0,70	0,70
				1,05	1,05	1,05
				1,40	1,40	1,40
				1,75	1,75	1,75
				2,10	2,10	2,10

📄

XPS

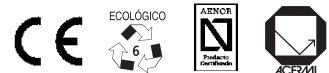

XPS · Cubiertas | XPS · Bajo teja

	λ	h	R	R	h	h	h
	0,035	100	0,35	0,35	0,35	0,35	0,35
				0,70	0,70	0,70	
				1,05	1,05	1,05	
				1,40	1,40	1,40	
				1,75	1,75	1,75	
				2,10	2,10	2,10	

Cornixpor®

®



Cornixpor Plus® Estándar

			D	g x A	En	ñ
		P	A	10	10	10
			B	10	10	10
			C	10	10	10
			D	10	10	10
			E	10	10	10
			F	10	10	10
		P	A	10	10	10
			B	10	10	10
			C	10	10	10
			D	10	10	10
			E	10	10	10
			F	10	10	10
		P	A	10	10	10
			B	10	10	10
			C	10	10	10
			D	10	10	10
			E	10	10	2
			F	10	10	3
		P	A	10	10	10
			B	10	10	10
			C	10	10	10
			D	10	10	10
			E	10	10	2
			F	10	10	3
		P	A	10	10	10
			B	10	10	10
			C	10	10	10
			D	10	10	10
			E	10	10	2
			F	10	10	3
		P	A	10	10	10
			B	10	10	10
			C	10	10	10
			D	10	10	10
			E	10	10	2
			F	10	10	3
		P	A	10	10	10
			B	10	10	10
			C	10	10	10
			D	10	10	10
			E	10	10	2
			F	10	10	3
		P	A	10	10	10
			B	10	10	10
			C	10	10	10
			D	10	10	10
			E	10	10	2
			F	10	10	3
				10	10	10
				10	10	10

Cornixpor Plus® Goterón

			D	g x A	h	h
		E	A	270 x 270	21,48	34,65
			B	220 x 220	17,31	30,48
			C	150 x 150	13,16	26,32
		G	A	270 x 270	19,75	32,89
			B	220 x 220	17,31	30,48
			C	150 x 150	13,16	26,32
		G	A	270 x 270	20,88	34,02
			B	220 x 220	19,31	32,45
			C	150 x 150	13,15	26,32
		G	A	270 x 270	23,58	36,76
			B	220 x 220	19,31	32,45
			C	150 x 150	14,48	27,63
		G	A	270 x 270	23,58	36,76
			B	220 x 220	19,31	32,45
			C	150 x 150	14,48	27,63
		G	A	270 x 270	23,58	36,76
			B	220 x 220	19,31	32,45
			C	150 x 150	14,48	27,63
		G	A	270 x 270	23,58	36,76
			B	220 x 220	19,31	23,45
			C	150 x 150	14,48	27,63
		G	A	270 x 270	23,58	36,76
			B	220 x 220	19,31	32,45
			C	150 x 150	14,48	27,63

TBT

TBT · Moldes

Í	Ø	h
0	0	3
0	0	0
0	0	5
0	0	7
0	0	0
0	0	0
0	0	0
0	0	0
0	0	2
0	0	0
0	0	0
0	0	0
0	0	0
0	0	0
0	0	0
0	0	0
0	0	0
0	0	0
0	0	0
0	0	0
0	0	0
0	0	0
0	0	0
0	0	0
0	0	0
0	0	0
0	0	0
0	0	0
0	0	0
0	0	0

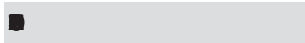
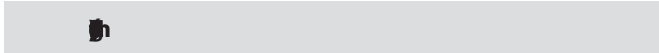
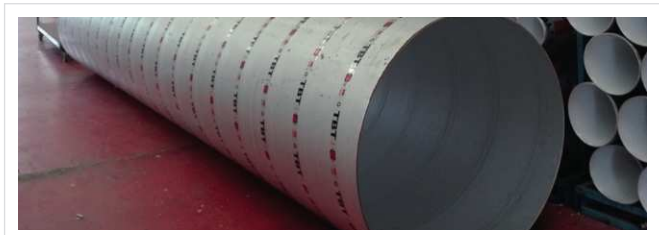

TBT · Moldes 



		En
150	150	2
200	150	2
	200	3
250	200	3
	250	3
300	200	5
	250	5
	300	5
350	200	5
	250	6
	300	6
	350	6
400	200	6
	250	6
	300	6
	350	6
	400	6
450	200	6
	250	6
	300	6
	350	6
	400	6
	450	6
500	200	6
	250	6
	300	6
	350	6
	400	6
	450	6
550	200	6
	250	6
	300	6
	350	6
	400	6
	450	6
600	200	6
	250	6
	300	6
	350	6
	400	6
	450	6
	500	6
550	6	
600	6	

TBT · Moldes 



		En
150	0	2
200	0	2
	0	2
250	0	2
	0	2
300	0	2
	0	2
	0	2
350	0	2
	0	2
	0	2
	0	2
400	0	2
	0	2
	0	2
	0	2
	0	2
450	0	2
	0	2
	0	2
	0	2
	0	2
	0	2

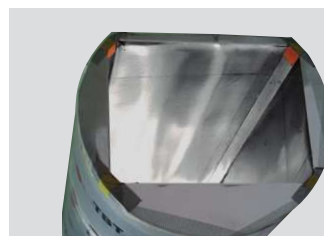
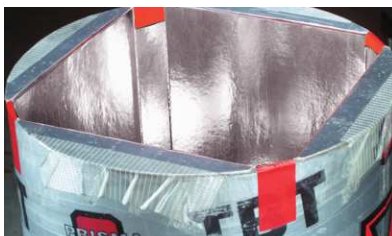

Granb [®] 



Granchio [®] 

	Modelo	Tipología	Superficie p m ² m ²	Gr m ³ m ²	Dim n	U n	m ² p	Dim p	Área m ²
	SAN5	A	645	0,009	60 x 80 x 5 h.	200	90,00	1,20 x 0,80 x 2,10	12,15
	SAN10	A	580	0,015	60 x 80 x 10 h.	160	72,00	1,20 x 0,80 x 2,00	13,64
	SAN15	B	547	0,030	50 x 75 x 15 h.	100	37,50	1,04 x 0,77 x 2,00	15,14
	SAN20	B	453	0,035	50 x 75 x 20 h.	100	37,50	1,04 x 0,77 x 2,05	16,64
	SAN25	B	599	0,040	50 x 75 x 25 h.	100	37,50	1,04 x 0,77 x 2,15	17,70
	SAN30	B	474	0,045	50 x 75 x 30 h.	100	37,50	1,04 x 0,77 x 2,20	18,01
	SAN35	B	641	0,055	50 x 75 x 35 h.	100	37,50	1,04 x 0,77 x 2,25	19,00
	SAN40	B	495	0,050	50 x 75 x 40 h.	100	37,50	1,04 x 0,77 x 2,30	20,35
	SAN45	B	492	0,062	50 x 75 x 45 h.	100	37,50	1,04 x 0,77 x 2,35	21,70
	SAN50	B	616	0,065	50 x 75 x 50 h.	90	33,75	1,04 x 0,77 x 2,20	23,04
	SAN55	B	321	0,070	50 x 75 x 55 h.	90	33,75	1,04 x 0,77 x 2,30	24,39

Granchio [®] 

	Modelo	Superficie p m ² m ²	Gr m ³ m ²	Dim n	U n	Área m ²
	SAN55MH	0	0	0	0	0
	SAN60MH	0	0	0	0	0
	SAN65MH	0	0	0	0	0
	SAN70MH	0	0	0	0	0

Granchio [®] 

	Modelo	Superficie p m ² m ²	Gr m ³ m ²	Dim n	U n	Área m ²
	01	0	0	0	0	0
	02	0	0	0	0	0
	03	0	0	0	0	0
	04	0	0	0	0	0
	05	0	0	0	0	0
	06	0	0	0	0	0

Granchio®

	D	P	E
	10	10	10
	15	15	15
	20	20	20
	25	25	25
	30	30	30
	35	35	35
	40	40	40
	45	45	45
	50	50	50



Complementos

010000



010000					
AN	AN m	AL	AL	AL	AL
AN	0	0	0	0	0
AN	2	0	0	0	2
AN	0	0	0	0	0
AN	3	0	0	0	0
AN	0	0	0	0	0
AN	0	0	0	0	0
AN	0	0	0	0	0
AN	0	0	0	0	0



010000					
AN	AN m	AL	AL	AL	AL
AN	0	0	0	0	0
AN	2	0	0	0	2
AN	0	0	0	0	0
AN	0	0	0	0	0
AN	0	0	0	0	0
AN	0	0	0	0	0



010000					
AN	AN m	AL	AL	AL	AL
AN	0	0	0	0	0
AN	0	0	0	0	0
AN	0	0	0	0	0



010000					
AN	AN m	AL	AL	AL	AL
AN	0	0	0	0	0
AN	0	0	0	0	0

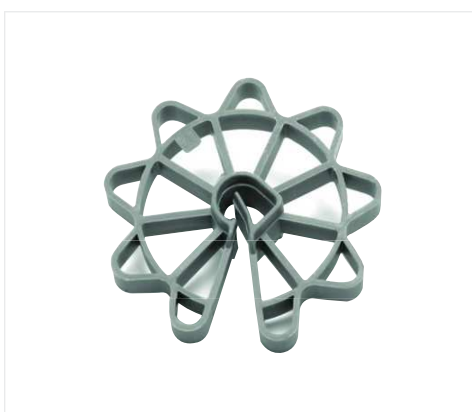

010000					
AN	AN m	AL	AL	AL	AL
AN	5	0	0	0	0
AN	0	0	0	0	0
AN	0	0	0	0	0
AN	0	0	0	0	0
AN	0	0	0	0	0
AN	0	0	0	0	0
AN	0	0	0	0	0
AN	0	0	0	0	0

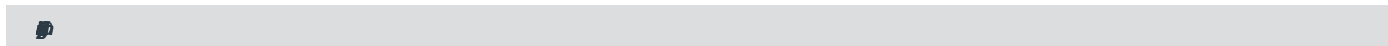

ACCESORIOS

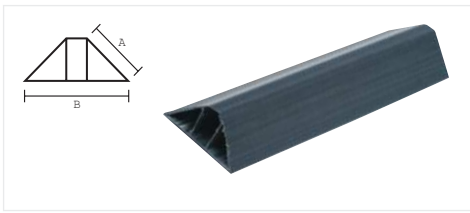

■					
Alt	Alt	U	U	U	U
0	0	0	0	0	0
0	0	0	0	0	0
0	0	0	0	0	0
0	0	0	0	0	0



■					
Alt	Alt	U	U	U	U
0	0	0	0	0	0
0	0	0	0	0	0
0	0	0	0	0	0



■					
Alt	Alt	U	U	U	U
0	0	0	0	0	0

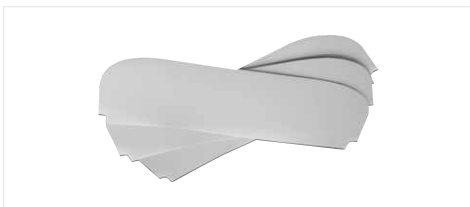

■					
Alt	Alt	U	U	U	U
0	0	0	0	0	0
0	0	0	0	0	0
0	0	0	0	0	0
0	0	0	0	0	0



■					
Alt	Alt	U	U	U	U
0	2	0	0	0	0
0	0	0	0	0	0



■					
Alt	Alt	U	U	U	U
0	2	0	0	0	0
0	0	0	0	0	0



■					
Alt	Alt	U	U	U	U
0	2	0	0	0	0



■					
Alt	Alt	U	U	U	U
0	0	0	0	0	4



■					
Alt	Alt	U	U	U	U
0	0	0	0	0	0

LABIAS



🇧🇪				
மீ	மீ	ம ² மீ	மீ	மீ ²
2	2	0	0	0
2	2	0	0	0
2	2	0	0	0
2	2	0	0	0



🇧🇪				
மீ	மீ	மீ	ம ² மீ	மீ ²
2	2	0	0	0
2	2	0	0	0
2	2	0	0	0



🇧🇪				
மீ	மீ	ம ² மீ	மீ	மீ ²
2	2	0	0	0



🇧🇪				
மீ	மீ	ம ² மீ	மீ	மீ ²
2	2	0	0	0



🇧🇪					
மீ	மீ	மீ	ம ² மீ	மீ	மீ
2	0	8	0	2	0
2	0	6	0	2	0
2	0	8	0	2	0
2	0	6	0	2	0
2	0	8	0	2	0
2	0	6	0	2	0

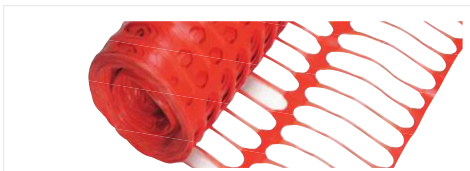

🇧🇪				
மீ	மீ ²	மீ	மீ	மீ ²
2	0	0	0	0

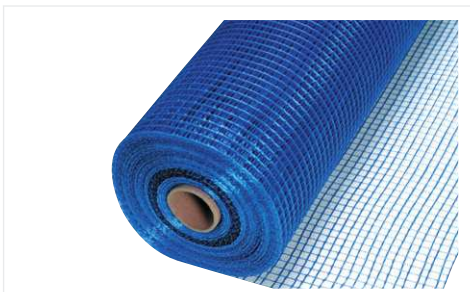

🇧🇪					
மீ	மீ ²	மீ	மீ	மீ	மீ ²
2	0	0	0	0	0
2	0	0	0	0	0
2	0	0	0	0	0
2	0	0	0	0	0

🔩



🔩				
මා	උ	ඒ	ආ	ඈ
෪	0	0	0	0
෪	0	0	0	0
෪	0	0	0	0
෪	0	0	0	0
෪	0	0	0	0
෪	0	0	0	0

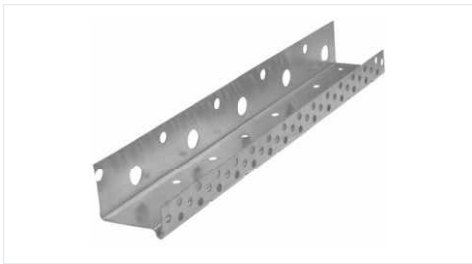

🔩					
මා	උ	ආ	ඈ	ඉ	ඊ
෪	0	0	0	0	0
෪		0			0
෪		0			0
෪		0			0
෪		0			0

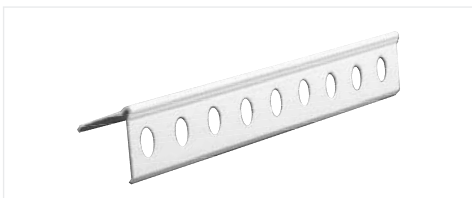

🔩					
මා	උ	ආ	ඈ	ඉ	ඊ
෪	0	0	0	0	0
෪	0	0	0	0	0



🔩					
මා	උ	ආ	ඈ	ඉ	ඊ
෪	0	0	0	0	0



🔩					
මා	උ	ආ	ඈ	ඉ	ඊ
෪	0	0	0	0	0

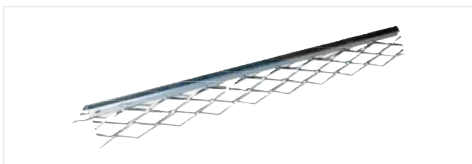

🔩					
මා	උ	ආ	ඈ	ඉ	ඊ
෪	0	0	0	0	0



🔩					
මා	උ	ආ	ඈ	ඉ	ඊ
෪	0	0	0	0	0
෪	0	0	0	0	0
෪	0	0	0	0	0



🔩					
මා	උ	ආ	ඈ	ඉ	ඊ
෪	0	0	0	0	0



- Poliid[®]**
- Poliid[®] Plus**
- Neod[®]**
- Neod[®] Plus**
- Poliid[®] Impacto[®]**
- Poliid[®] Impacto[®] Plus**

AISLAMIENTOS PARA SUELO RADIANTE



**SECTORES
INDUSTRIALES**

Poliid®



®



Poliid® 33

 	λ	A m	B m	C m	D m	R (m ² /K)	U W/m ²	m ²	n	2
										0
	0	60 x 60	0	1	2	0	6	0		
			6	7	2	0	4	3		
			6	2	3	0	2	3		
			5	0	6	0	1	4		
			6	3	4	0	9	9		
			0	4	5	0	8	0		

Poliid® 34

 	λ	A m	B m	C m	D m	R (m ² /K)	U W/m ²	m ²	n	2
										0
	0	60 x 60	0	1	2	0	6	0		
			6	7	2	0	4	3		
			6	2	3	0	2	3		
			5	0	6	0	1	4		
			6	3	4	0	9	9		
			0	4	5	0	8	0		

Poliid® 35

	λ	A m	B m	C m	D m	R (m ² /K)	U W/m ²	m ²	n	2
										0
	0	60 x 60	0	1	2	0	6	0		
			6	7	2	0	4	3		
			6	2	3	0	2	3		
			5	0	6	0	1	4		
			6	3	4	0	9	9		
			0	4	5	0	8	0		

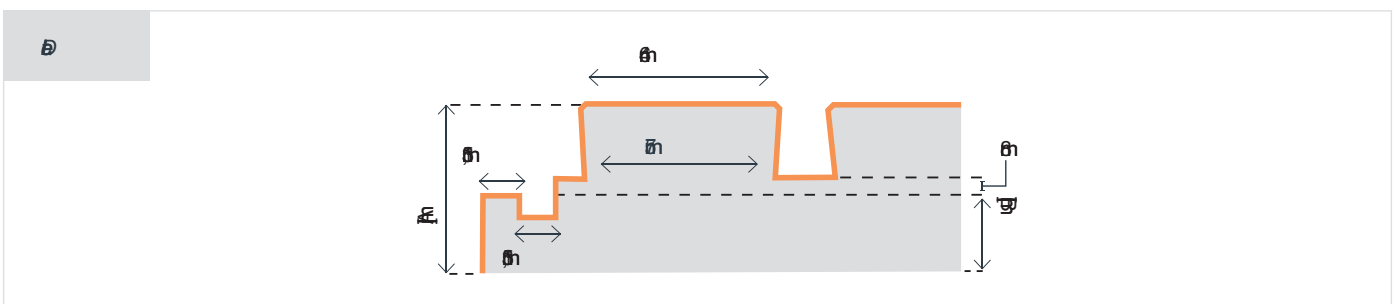

Poliid

Plus

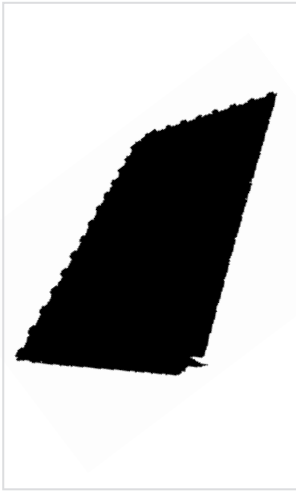

Espesor (cm)	λ (W/mK)	A (m)	B (m)	Peso (kg/m²)	Resistencia térmica (m²K/W)	U (W/m²K)	Superficie (m²)	Volumen (m³)	
2	0,03	0,6	0,6	0,8	4	0,7	0,2	0,1	
3			0,2	0,6	0,6	0,2	0,2	0,1	
4	0,03	0,6	0,3	0,3	0,9	0,6	0,4	0,08	
5			0,4	0,3	0,2	0,1	0,2	0,08	
6			0,2	0,2	0,2	0,0	0,0	0,0	0,0
8			0,3	0,3	0,2	0,0	0,0	0,0	0,0
9			0,3	0,3	0,3	0,2	0,0	0,0	0,0

Neod

®

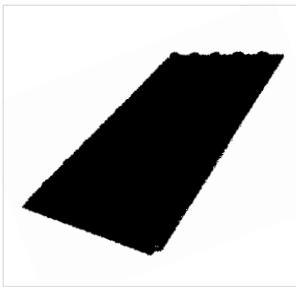

Espesor (cm)	λ (W/mK)	A (m)	B (m)	Peso (kg/m²)	Resistencia térmica (m²K/W)	U (W/m²K)	Superficie (m²)	Volumen (m³)
2	0,03	0,6	0,6	2	3	0,2	0,2	0,02
3			0,6	3	4	0,0	0,0	0,0

Neod

Plus

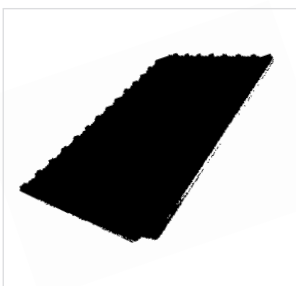

Espesor (cm)	λ (W/mK)	A (m)	B (m)	Peso (kg/m²)	Resistencia térmica (m²K/W)	U (W/m²K)	Superficie (m²)	Volumen (m³)
2	0,03	0,6	0,6	0,8	2	0,1	0,2	0,01
3			0,5	0,3	0,9	0,8	0,0	0,0

Polimacto®

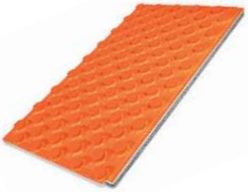

	λ	Δ	Π	Π	Π	R	Π	κ
	(m)	(m)	(m)	(m)	(m)	(m ² /W)	(m)	(m ²)
■	0,035	0,100 x 0,100	0,100	0,100	0,100	2		
■	0,035	0,100	0,100	0,100	0,100	4		

Polimacto® Plus



	λ	Δ	Π	Π	Π	R	Π	κ
	(m)	(m)	(m)	(m)	(m)	(m ² /W)	(m)	(m ²)
■	0,035	0,100 x 0,100	0,100	0,100	0,100	0		

BANDA PERIMETRAL CON FALDO Y ADHESIVO DE 25 mm

	Π	Π	Π	κ
	(m)	(m)	(m)	(m ²)
■	0	0	7	0,90

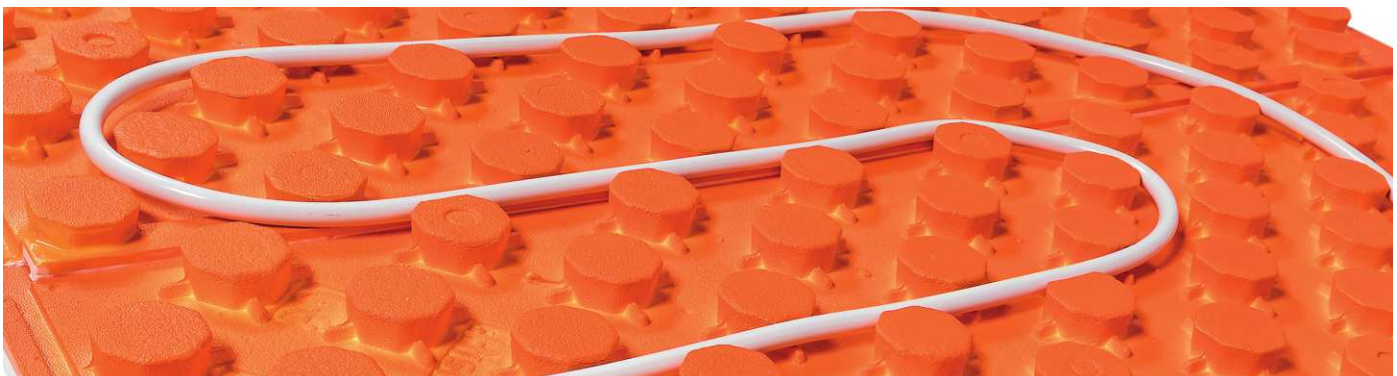

Silver [®]

Poliblock [®]

Tecob [®]

Polib [®]

SISTEMAS ESTRUCTURALES

SISTEMAS DE
SUSPENSIÓN
ACÚSTICA









Silver  [®]

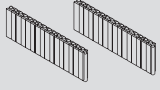
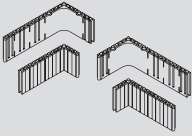

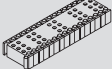
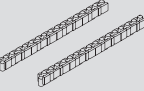
Silver  [®] |   

$\lambda = 0,029 \text{ W/mK}$

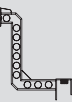
	■	■	■ m	■	■
	■	■ ■	■ ■	■ ■	■
	■	■ ■ ■ ■	■ ■ ■ ■	■ ■	■
	■	■	■	■	■
	■	■	■	■	■
	■	■ ■	■ ■	■	■
	■	■	■	■	■
	■	■	■	■	■
	■	■	■	■	■
	■	■	■	■	■

Se sirve desmontado



Silver *b* [®]



m

$\lambda = 0,029 \text{ W/mK}$

	Re	Pa	Re m	Pa	K
	Re	Pa	Re	Pa	
	Re	Pa	Re	Pa	2
	Re	Pa	Re	Pa	6
	Re	Pa	Re	Pa	2
	Re	Pa	Re	Pa	
	Re	Pa	Re	Pa	
	Re	Pa	Re	Pa	
	Re	Pa	Re	Pa	
	Re	Pa	Re	Pa	
	Re	Pa	Re	Pa	
	Re	Pa	Re	Pa	







Silver [®]

0-5000

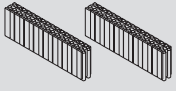
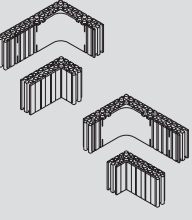
m

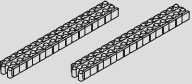
$\lambda = 0,029 \text{ W/mK}$

	Ø	Ø	Ø	Ø	Ø
	Ø	Ø	Ø	Ø	Ø
	Ø	Ø	Ø	Ø	Ø
	Ø	Ø	Ø	Ø	Ø
	Ø	Ø	Ø	Ø	Ø
	Ø	Ø	Ø	Ø	Ø
	Ø	Ø	Ø	Ø	Ø

Se sirve desmontado







Poliblock m [®]

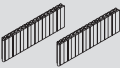
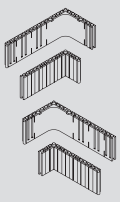

Poliblock muro [®] |

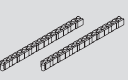
$\lambda = 0,034 \text{ W/mK}$

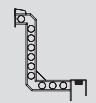
	h	h ₀	h ₁	h ₂	h ₃	K
	h	h	h	h	h	
	h	h	h	h	h	
	h	h	h	h	h	
	h	h	h	h	h	
	h	h	h	h	h	
	h	h	h	h	h	
	h	h	h	h	h	

Se sirve desmontado





Tecowob® Forjados



	Modelo	Diámetro	Dimensiones	Material
	TWYUNIN12	Ø	1200 x 700 x 100	
	TWYUNIN15	Ø		
	TWYUNINCAP	Ø	800 x 845 x 30	



	Modelo	Diámetro	Dimensiones	Material
	TWYUNIN12	Ø	1200 x 700 x 100	
	TWYUNIN15	Ø		
	TWYUNINCAP	Ø	800 x 845 x 30	

Ø

Tecowob® Forjados



	Modelo	Diámetro	Dimensiones	Material
	TWYUNIN12	Ø	1200 x 700 x 100	
	TWYUNIN15	Ø		
	TWYUNIN18	Ø		
	TWYUNINCAP	Ø	800 x 845 x 30	



	Modelo	Diámetro	Dimensiones	Material
	TWYUNIN12	Ø	1200 x 700 x 100	
	TWYUNIN15	Ø		
	TWYUNIN18	Ø		
	TWYUNINCAP	Ø	800 x 845 x 30	

Ø

Tecowob® Forjados 



	E	D	F	B
	12/	8	0	
	12/	8	5	



	E	D	F	B
	12/	8	0	
	12/	8	5	







NERVIO 120mm						
Q	P	W	H	L	W	B
		W	H	L	W	B
		0	0	0	0	
		0	0	0	0	
		0	0	0	0	

■

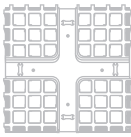

NERVIO 120mm						
Q	P	W	H	L	W	B
		W	H	L	W	B
		0	0	0	0	
		0	0	0	0	
		0	0	0	0	

■

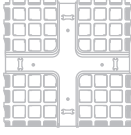
NERVIO 140mm						
Q	P	W	H	L	W	B
		W	H	L	W	B
		0	0	0	0	
		0	0	0	0	
		0	0	0	0	

PLACA CAPITEL PARA TODOS LOS NERVIOS

Q	P	W	H	B
0	0	0	0	0

EPS - 1

EPS - 2

EPS - 3

EPS - 4

EMBALAJE Y APLICACIONES INDUSTRIALES

**SECTOR
INDUSTRIAL**



EPS Aislenvas - ၆၈



	D	A	A	A	A	A	A	A	

	ρ (Kg/m3)	0	2	5	0	2	0	5	0
	၆၈								
	၆၈								
၆၈									



			D	A	A	A	A	A	A		

			ρ (Kg/m3)	0	2	5	0	2	0	5	0
			၆၈								
			၆၈								
၆၈											

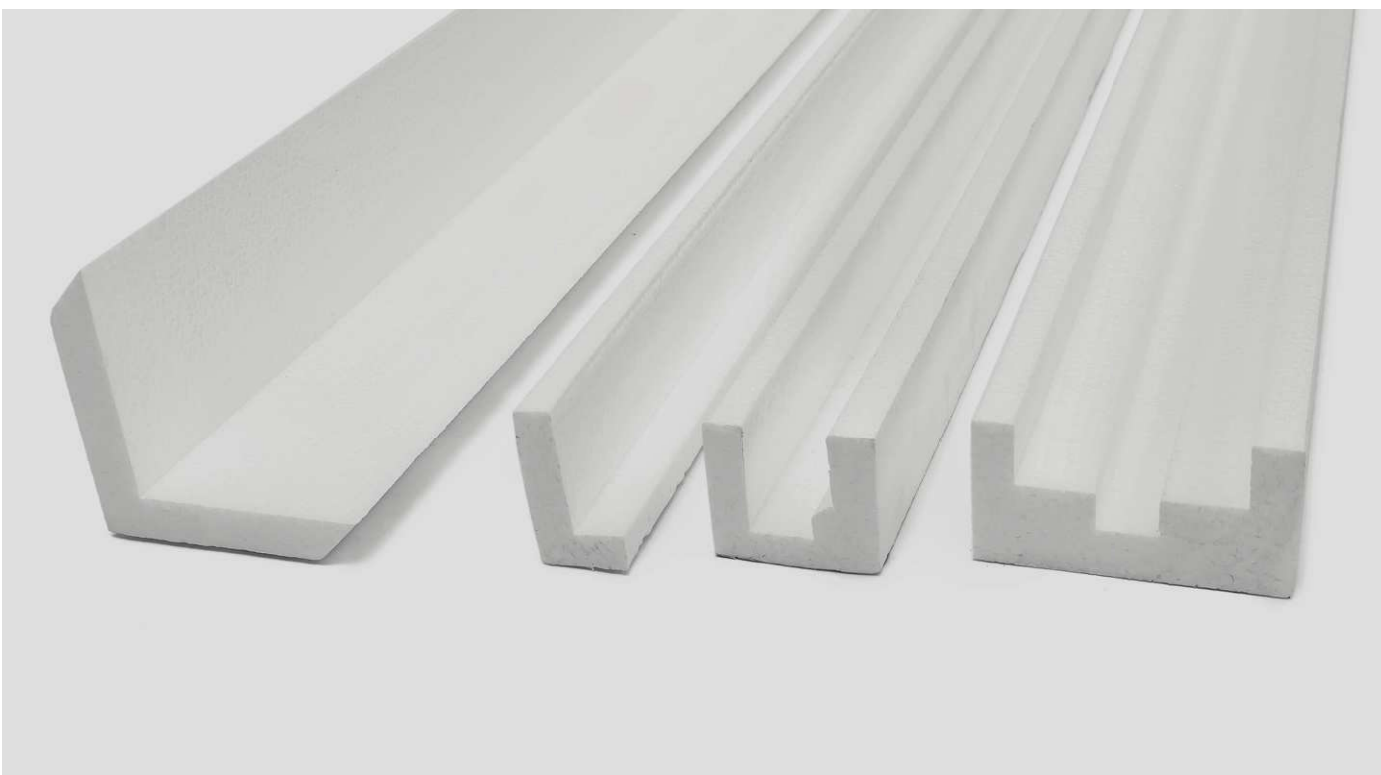

MA

	D	A
	ρ (Kg/m ³)	\emptyset

B

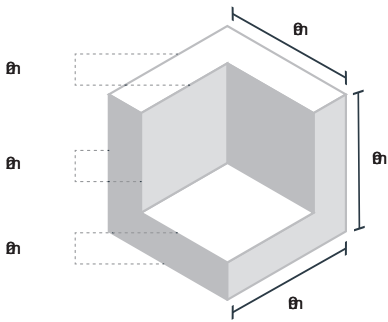

B

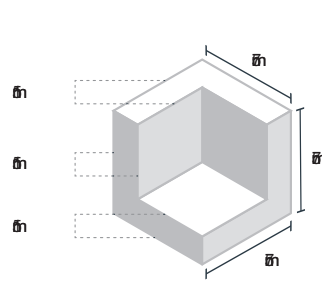

B

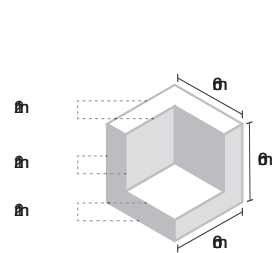

B

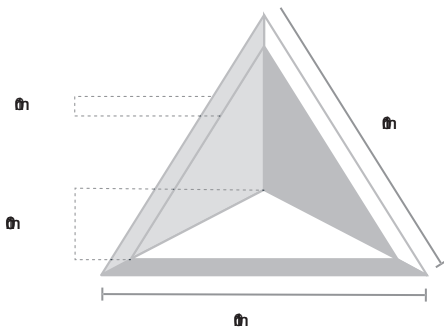

B

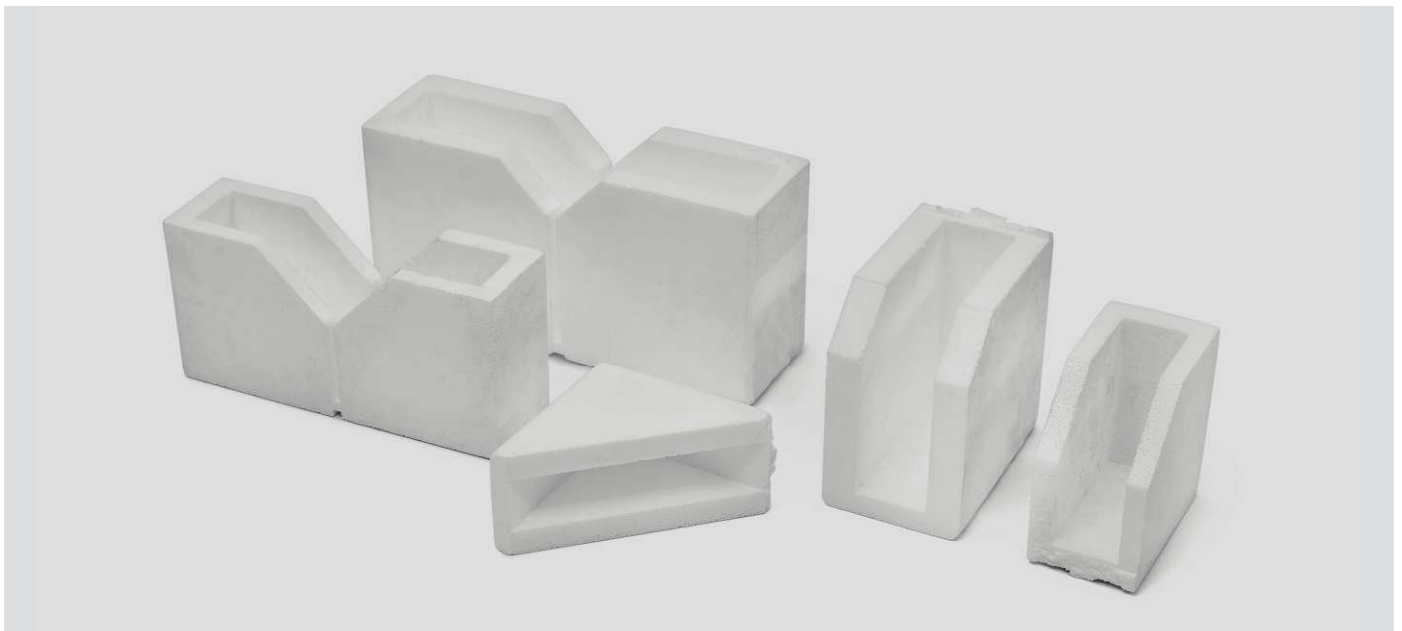
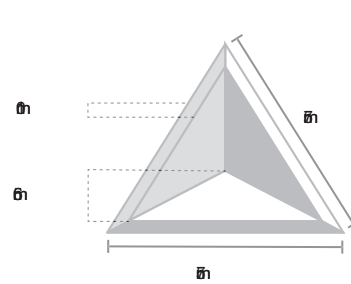

MA

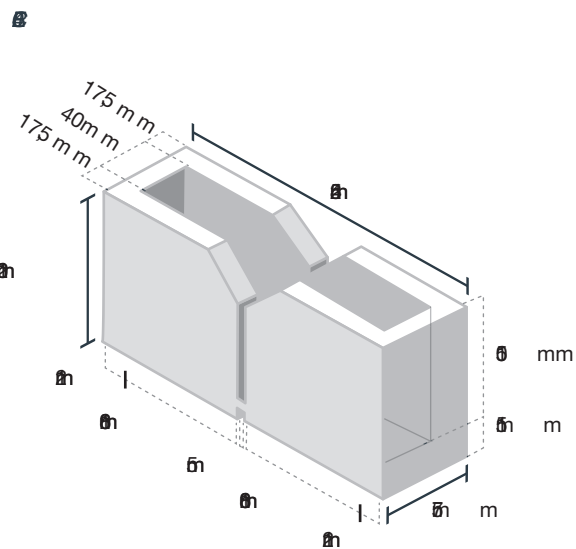
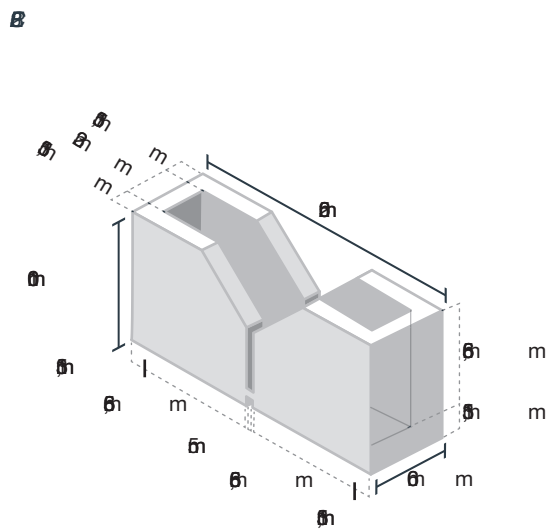
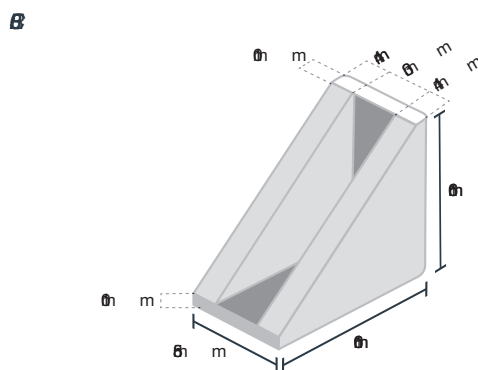
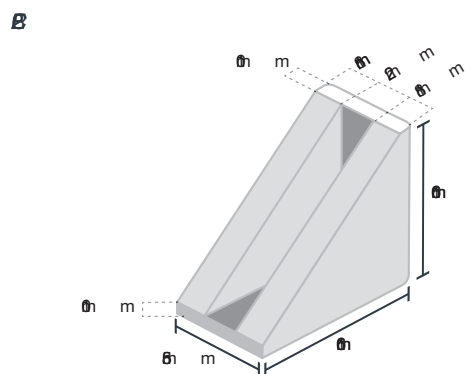
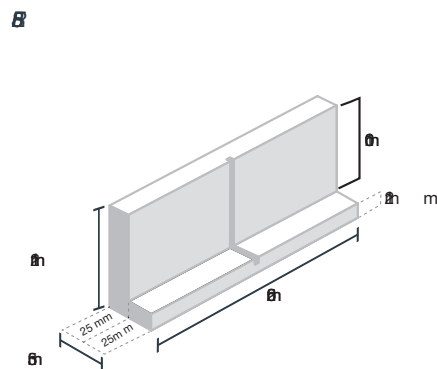
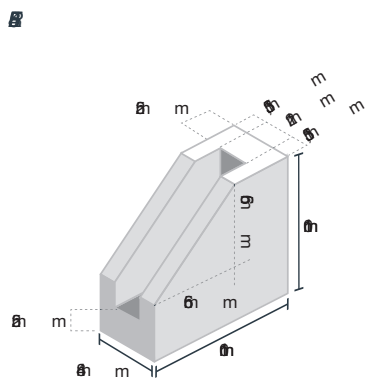
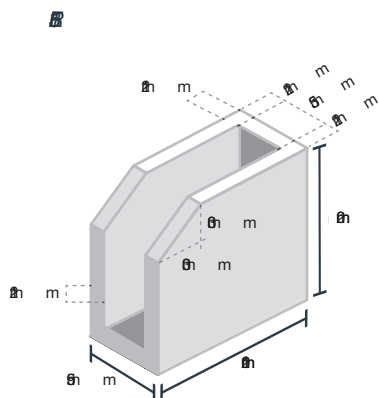

MA

MA



D	A	A	A	A	A	A	A	A
/ / / / / / / / / /								
ρ (Kg/m ³)	0	2	5	0	2	0	5	0

EPS Aislenvas -

airpop[®]
engineered air

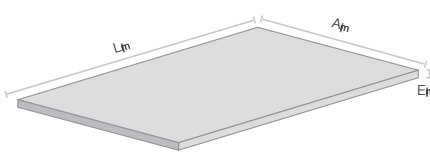

	Ⓟ	Ⓛ	Ⓜ	Ⓟ	Ⓛ	Ⓜ	Ⓟ	Ⓛ	Ⓜ

	ρ (Kg/m3)	0	2	5	0	2	0	5	0
	Ⓜ								
Ⓜ									Ⓜ
Ⓜ									Ⓜ



	Ⓟ	Ⓛ	Ⓜ	Ⓟ	Ⓛ	Ⓜ	Ⓟ	Ⓛ	Ⓜ

ρ (Kg/m3)	0	2	5	0	2	0	5	0	

EPS -





airpop[®]
engineered air





EPS Aislenvas - Perla virgen

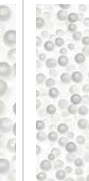

Ⓟ	Ⓛ		Ⓜ	Ⓟ		
	Ⓜ	Ⓟ		Ⓜ	Ⓟ	

Ⓟ	Ⓟ					
	0		5	0		
Ⓜ	8	8	6	8	2	
m ² Ⓟ	∅		∅	∅		
Ⓜ						

Ⓟ	Ⓟ	Ⓟ
	Ⓜ	

Ⓟ	Ⓟ	
	2	5
Ⓜ	7	8
m ² Ⓟ	∅	
Ⓜ		
		

EPS Aislenvas - ~~h~~



E_n	D	A	A	A	A	A	A	A	
	ρ (Kg/m ³)	0	2	5	0	2	0	5	
	E_n								E_n
	E_n								E_n
	E_n								E_n



D	A	A	A	
	ρ (Kg/m ³)	0	2	5





ISLENVAS

