

 prhie[®]



C A T A L O G O P R O D U C T O

1	Mecanismos de descarga <i>Flush valve mechanism</i>		4	Otros accesorios <i>Other accessories</i>	
	Mecanismo <i>Flush valve</i>	8		Sifones para fregadera <i>Sink traps</i>	36
	Accesorios y recambios <i>Accessories & Spare parts</i>	21		Sifón para lavadora <i>Washing-machines traps</i>	36
	Compatibilidades <i>Compatibilities</i>	24		Sistema de desagüe para bañeras <i>Water drain system for bath tubs</i>	37
2	Mecanismos de alimentación <i>Fill valve mechanism</i>			Sifón para platos de ducha <i>Shower tray traps</i>	37
	Mecanismo <i>Fill valve</i>	28		Tubos extensibles <i>Extensible pipes</i>	38
	Accesorios y recambios <i>Accessories & Spare parts</i>	31		Accesorios para conexión WC <i>Accessories for WC connection</i>	39
3	Accesorios cromados <i>Chrome plated accessories</i>		5	Condiciones generales <i>General sales conditions</i>	42
	Sifón para lavabo y bidet <i>Toiled & bidet trap</i>	32			
	Válvulas y accesorios <i>Valves & accessories</i>	34			



Nosotros

PRHIE COMPONENTS S.L. fue creada en Barcelona en el año 1965, fabricante líder en descargas y válvulas-flotador de última tecnología para cisternas de inodoros, nos distinguimos por la capacidad de desarrollo, innovación y una elevada exigencia en la calidad de nuestros productos.

Comprometidos con el éxito, sabíamos que un enfoque nuevo era el único camino a seguir. Adoptamos formas innovadoras de pensar, conceptualizamos y producimos nuevos productos, y creamos una marca que se mantiene fiel a sus valores fundamentales:

Ser diferente

¡Quita lo viejo pon lo nuevo! Nunca hemos evitado hacer las cosas de manera diferente, ya sea que eso signifique lanzar nuevos productos al mercado, como nuestra válvula de llenado de doble entrada For-All, o simplemente nuestra ética de trabajo. Realmente somos una compañía única, y eso se refleja en nuestras interacciones con nuestros clientes.

Estar involucrado

Desde la creación de productos nuevos y vanguardistas, hasta responder preguntas sobre la instalación, nos enorgullecemos de nuestra participación en todos los aspectos de lo que sucede en Prhie. Puede que tengamos la mente en muchos sitios, pero ello asegura que los productos que producimos y el servicio que brindamos sean de primera categoría, orientados al cliente y siempre con un compromiso a la excelencia.

Ser leal

Cuando creamos nuestro equipo, creamos una sólida red de personas con talento que, juntas, pudieron transformar a Prhie en lo que es hoy. Somos ferozmente leales entre nosotros y realmente creemos en la fortaleza no solo de nuestro vínculo interno sino también de la conexión con nuestros clientes.



I+D+I

Todo comienza con un trozo de papel. Se esbozan ideas para nuevos productos hasta que estamos seguros de que nuestro nuevo diseño es efectivo, fácil de instalar y adecuado para su propósito.

Este concepto luego se transfiere a un software de diseño 3D, esto nos permite simular el flujo de agua, las características térmicas y la presión del producto asegurando el rendimiento y la fiabilidad.

FABRICACION

Una vez que todo encaja sin problemas, enviamos este diseño a una impresora 3D. Cada parte se imprime, se ensambla y se prueba en condiciones reales. Una vez que tenemos el modelo 3D perfeccionado, estará listo para la producción.

Se crean los moldes de inyección de plástico y producimos en serie cada una de las piezas siguiendo un estricto control de calidad utilizando materias primas de primeras marcas.

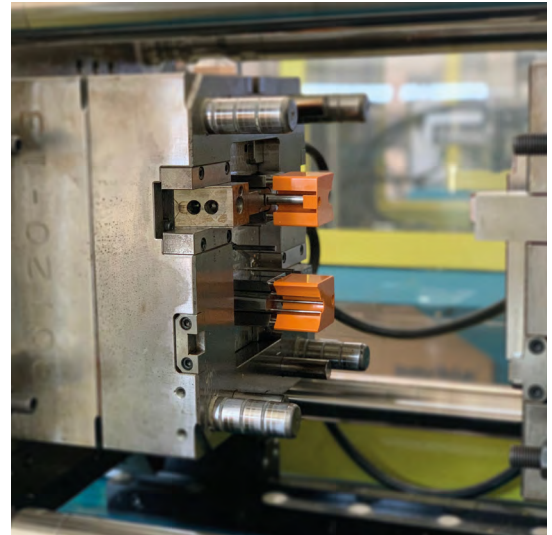



ENSAMBLAJE

Se ensambla cada una de las piezas siguiendo un estricto protocolo de comprobaciones para que el producto funcione correctamente una vez instalado.

PRODUCTO

Desde el diseño hasta la fabricación, el ensamblaje y la instalación, estamos involucrados en cada paso del camino para asegurarnos de que podamos estar orgullosos de nuestros productos y que pueda estar seguro de su simplicidad y eficacia.



NIÁGARA⁺



Mecanismo de descarga universal con doble pulsador.
Válida para todas las cisternas bajas del mercado.
Montaje rápido y sencillo, sin herramientas.
Incluidos adaptadores para base blanca ROCA* D2D, base gris ROCA* VICTORIA y base roscada.
250.000 ciclos garantizados.
Permite ahorrar hasta un 62% de agua, al descargar la cisterna de su inodoro.
Máxima estanqueidad garantizada.
Alta resistencia a productos químicos y de limpieza.
Fácil mantenimiento.

*Universal flush valve with double push button.
Compatible with close coupled tanks.
Fast and easy installation system, no tools needed.
Adapters for ROCA'S* white base D2D, ROCA'S* grey base VICTORIA & threaded base included.
250,000 cycles guaranteed.
Save up to 62% of water in each flush.
Water sealing guaranteed.
High resistance to chemical and cleaning products.
Easy maintenance.*

Compatibilidad

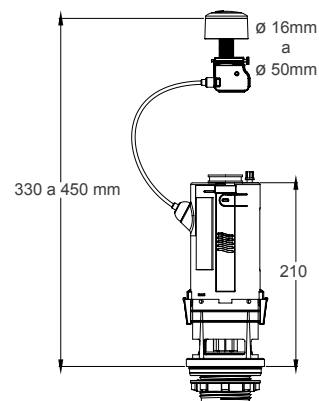

Código Code	Descripción Description	Unid.-Caja Units-Box	Precio Price
70355	Mecanismo / Flush valve Niágara +	18	27,97 €

Materiales / Materials : ABS / Pp / Hips / Pom

NIÁGARA⁺



Mecanismo de descarga universal con doble pulsador.
Válida para todas las cisternas bajas del mercado.
Montaje rápido y sencillo, sin herramientas.
Incluidos adaptadores para base blanca ROCA* D2D, base gris ROCA* VICTORIA y base roscada.
250.000 ciclos garantizados.
Permite ahorrar hasta un 62% de agua, al descargar la cisterna de su inodoro.
Máxima estanqueidad garantizada.
Alta resistencia a productos químicos y de limpieza.
Fácil mantenimiento.

*Universal flush valve with double push button.
Compatible with close coupled tanks.
Fast and easy installation system, no tools needed.
Adapters for ROCA'S* white base D2D, ROCA'S* grey base VICTORIA & threaded base included.
250,000 cycles guaranteed.
Save up to 62% of water in each flush.
Water sealing guaranteed.
High resistance to chemical and cleaning products.
Easy maintenance.*

Compatibilidad

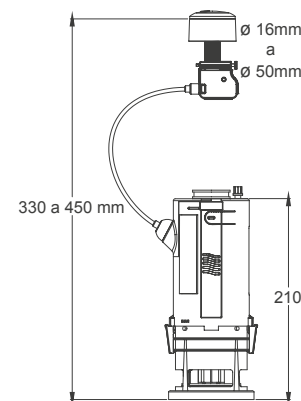

Código
Code

Descripción
Description

Unid.-Caja
Units-Box

Precio
Price

70345

Mecanismo / Flush valve Niágara +

18

21,73 €

Materiales / Materials : ABS / Pp / Hips / Pom

NIÁGARA⁺



Mecanismo de descarga universal con doble pulsador.
Válida para todas las cisternas bajas del mercado.
Montaje rápido y sencillo, sin herramientas.
Sistema anti-vandálico con bloqueo de la tapa de la cisterna.
Incluidos adaptadores para base blanca ROCA* D2D, base gris ROCA* VICTORIA y base roscada.
250.000 ciclos garantizados.
Permite ahorrar hasta un 62% de agua, al descargar la cisterna de su inodoro.
Máxima estanqueidad garantizada.
Alta resistencia a productos químicos y de limpieza.
Fácil mantenimiento.

*Universal flush valve with double push button.
Compatible with close coupled tanks.
Fast and easy installation system, no tools needed.
Anti-vandalic system, with locking system of the tanks's lid.
Adapters for ROCA'S* white base D2D, ROCA'S* grey base VICTORIA & threaded base included.
250,000 cycles guaranteed.
Save up to 62% of water in each flush.
Water sealing guaranteed.
High resistance to chemical and cleaning products
Easy maintenance.*

Compatibilidad

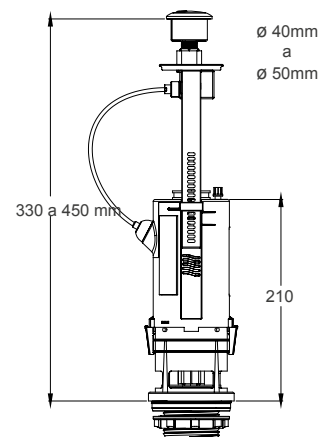

Código Code	Descripción Description	Unid.-Caja Units-Box	Precio Price
70335	Mecanismo / Flush valve Niágara +	18	29,36 €

Materiales / Materials : ABS / Pp / Hips / Pom

NIÁGARA⁺



Mecanismo de descarga universal con doble pulsador.
Válida para todas las cisternas bajas del mercado.
Montaje rápido y sencillo, sin herramientas.
Sistema anti-vandálico con bloqueo de la tapa de la cisterna.
Incluidos adaptadores para base blanca ROCA* D2D, base gris ROCA* VICTORIA y base roscada.
250.000 ciclos garantizados.
Permite ahorrar hasta un 62% de agua, al descargar la cisterna de su inodoro.
Máxima estanqueidad garantizada.
Alta resistencia a productos químicos y de limpieza.
Fácil mantenimiento.

*Universal flush valve with double push button.
Compatible with close coupled tanks.
Fast and easy installation system, no tools needed.
Anti-vandalic system, with locking system of the tanks's lid.
Adapters for ROCA'S* white base D2D, ROCA'S* grey base VICTORIA & threaded base included.
250,000 cycles guaranteed.
Save up to 62% of water in each flush.
Water sealing guaranteed.
High resistance to chemical and cleaning products
Easy maintenance.*

Compatibilidad

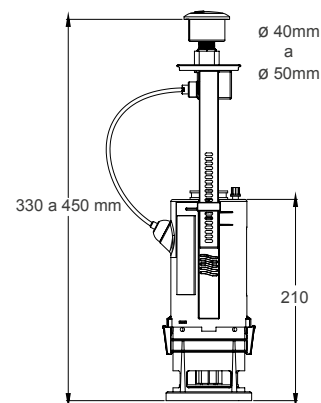

Código
Code

Descripción
Description

Unid.-Caja
Units-Box

Precio
Price

70325

Mecanismo / Flush valve Niágara +

18

23,06 €

Materiales / Materials : ABS / Pp / Hips / Pom

AQUA



Mecanismo de descarga universal con doble pulsador.
Válida para todas las cisternas bajas del mercado.
Montaje rápido y sencillo, sin herramientas.
Incluidos adaptadores para base blanca ROCA* D2D y base roscada.
250.000 ciclos garantizados.
Permite ahorrar hasta un 62% de agua, al descargar la cisterna de su inodoro.
Máxima estanqueidad garantizada.
Alta resistencia a productos químicos y de limpieza.
Fácil mantenimiento.

*Universal flush valve with double push button.
Compatible with close coupled tanks.
Fast and easy installation system, no tools needed.
Adapters for ROCA'S* white base D2D & threaded base included.
250,000 cycles guaranteed.
Save up to 62% of water in each flush.
Water sealing guaranteed.
High resistance to chemical and cleaning products.
Easy maintenance.*

Compatibilidad

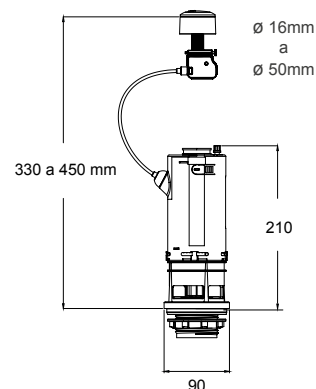

Código Code	Descripción Description	Unid.-Caja Units-Box	Precio Price
70313	Mecanismo / Flush valve Aqua	20	23,97 €

Materiales / Materials : ABS / Pp / Hips / Pom

AQUA



Mecanismo de descarga universal con doble pulsador.
 Válida para todas las cisternas bajas del mercado.
 Montaje rápido y sencillo, sin herramientas.
 Incluidos adaptadores para base blanca ROCA* D2D y base roscada.
 250.000 ciclos garantizados.
 Permite ahorrar hasta un 62% de agua, al descargar la cisterna de su inodoro.
 Máxima estanqueidad garantizada.
 Alta resistencia a productos químicos y de limpieza.
 Fácil mantenimiento.

*Universal flush valve with double push button.
 Compatible with close coupled tanks.
 Fast and easy installation system, no tools needed.
 Adapters for ROCA'S* white base D2D & threaded base included.
 250,000 cycles guaranteed.
 Save up to 62% of water in each flush.
 Water sealing guaranteed.
 High resistance to chemical and cleaning products.
 Easy maintenance.*

Compatibilidad

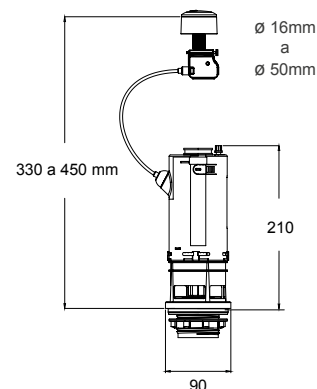

Código Code	Descripción Description	Unid.-Caja Units-Box	Precio Price
70312	Mecanismo / Flush valve Aqua	25	21,49 €

Materiales / Materials : ABS / Pp / Hips / Pom

AQUA



Mecanismo de descarga universal con doble pulsador.
Válida para todas las cisternas bajas del mercado.
Montaje rápido y sencillo, sin herramientas.
Incluidos adaptadores para base blanca ROCA* D2D y base roscada.
250.000 ciclos garantizados.
Permite ahorrar hasta un 62% de agua, al descargar la cisterna de su inodoro.
Máxima estanqueidad garantizada.
Alta resistencia a productos químicos y de limpieza.
Fácil mantenimiento.

*Universal flush valve with double push button.
Compatible with close coupled tanks.
Fast and easy installation system, no tools needed.
Adapters for ROCA'S* white base D2D & threaded base included.
250,000 cycles guaranteed.
Save up to 62% of water in each flush.
Water sealing guaranteed.
High resistance to chemical and cleaning products.
Easy maintenance.*

Compatibilidad

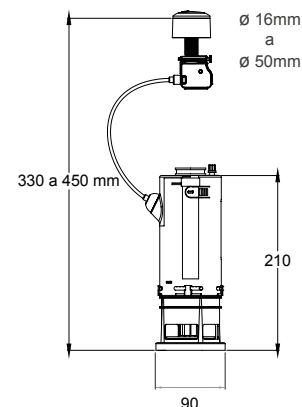

Código Code	Descripción Description	Unid.-Caja Units-Box	Precio Price
70311	Mecanismo / Flush valve Aqua	25	20,66 €

Materiales / Materials : ABS / Pp / Hips / Pom

NIÁGARA



Mecanismo de descarga universal con doble pulsador.
 Válida para todas las cisternas bajas del mercado.
 Montaje rápido y sencillo, sin herramientas.
 Rebosadero ajustable en altura, sin cortes.
 Incluido adaptador para base roscada.
 250.000 ciclos garantizados.
 Permite ahorrar hasta un 62% de agua, al descargar la cisterna de su inodoro.
 Máxima estanqueidad garantizada.
 Alta resistencia a productos químicos y de limpieza.
 Fácil mantenimiento.

*Universal flush valve with double push button.
 Compatible with close coupled tanks.
 Fast and easy installation system, no tools needed.
 Adjustable overflow.
 Adapters for threaded base included.
 250,000 cycles guaranteed.
 Save up to 62% of water in each flush.
 Water sealing guaranteed.
 High resistance to chemical and cleaning products.
 Easy maintenance.*

Compatibilidad

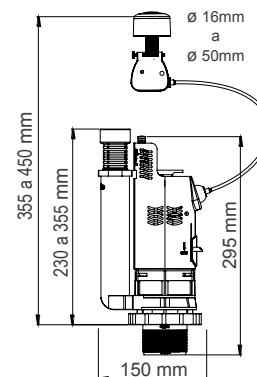

Código Code	Descripción Description	Unid.-Caja Units-Box	Precio Price
70300	Mecanismo / Flush valve Niágara	16	27,97 €

Materiales / Materials : ABS / Pp / Hips / Pom

HYDRO



Mecanismo de descarga universal interrumpible con simple pulsador.
Sistema Start & Stop, maximo ahorro de agua
Válida para todas las cisternas bajas del mercado.
Montaje rápido y sencillo, sin herramientas.
Regulación automática de altura del pulsador patentado
Incluidos adaptadores para base blanca ROCA* D2D y base roscada.
250.000 ciclos garantizados.
Máxima estanqueidad garantizada.
Alta resistencia a productos químicos y de limpieza.
Fácil mantenimiento.

*Interruptible universal flush valve with simple push button.
Start & Stop system, save water
Compatible with close coupled tanks.
Fast and easy installation system, no tools needed.
Patented automatic push height adjustment
Adapters for ROCA'S* white base D2D & threaded base included.
250,000 cycles guaranteed.
Save up to 62% of water in each flush.
Water sealing guaranteed.
High resistance to chemical and cleaning products.
Easy maintenance.*

Compatibilidad

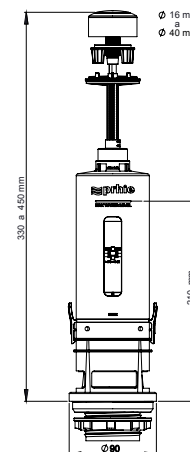

Código
Code

Descripción
Description

Unid.-Caja
Units-Box

Precio
Price

70113

Mecanismo / Flush valve Hydro

18

18,18 €

Materiales / Materials : ABS / Pp / Hips / Pom

HYDRO



Mecanismo de descarga universal interrumpible con simple pulsador.
Sistema Start & Stop, maximo ahorro de agua
Válida para todas las cisternas bajas del mercado.
Montaje rápido y sencillo, sin herramientas.
Regulación automática de altura del pulsador patentado
Incluidos adaptadores para base blanca ROCA* D2D y base roscada.
250.000 ciclos garantizados.
Máxima estanqueidad garantizada.
Alta resistencia a productos químicos y de limpieza.
Fácil mantenimiento.

*Interruptible universal flush valve with simple push button.
Start & Stop system, save water
Compatible with close coupled tanks.
Fast and easy installation system, no tools needed.
Patented automatic push height ajustament
Adapters for ROCA'S* white base D2D & threaded base included.
250,000 cycles guaranteed.
Save up to 62% of water in each flush.
Water sealing guaranteed.
High resistance to chemical and cleaning products.
Easy maintenance.*

Compatibilidad

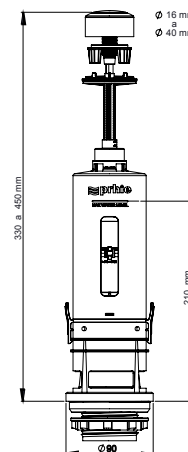

Código Code	Descripción Description	Unid.-Caja Units-Box	Precio Price
70112	Mecanismo / Flush valve Hydro	32	16,53 €

Materiales / Materials : ABS / Pp / Hips / Pom

HYDRO



Mecanismo de descarga universal interrumpible con simple pulsador.
Sistema Start & Stop, maximo ahorro de agua
Válida para todas las cisternas bajas del mercado.
Montaje rápido y sencillo, sin herramientas.
Regulación automática de altura del pulsador patentado
Incluidos adaptadores para base blanca ROCA* D2D y base roscada.
250.000 ciclos garantizados.
Máxima estanqueidad garantizada.
Alta resistencia a productos químicos y de limpieza.
Fácil mantenimiento.

*Interruptible universal flush valve with simple push button.
Start & Stop system, save water
Compatible with close coupled tanks.
Fast and easy installation system, no tools needed.
Patented automatic push height ajustament
Adapters for ROCA'S* white base D2D & threaded base included.
250,000 cycles guaranteed.
Save up to 62% of water in each flush.
Water sealing guaranteed.
High resistance to chemical and cleaning products.
Easy maintenance.*

Compatibilidad

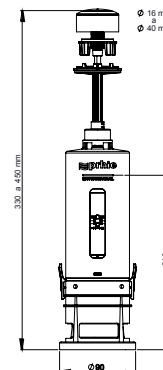

Código
Code

Descripción
Description

Unid.-Caja
Units-Box

Precio
Price

70111

Mecanismo / Flush valve Hydro

32

14,88 €

Materiales / Materials : ABS / Pp / Hips / Pom

AIGUA



Mecanismo de descarga de tirador.
 Válida para cisternas bajas.
 Incluye tirador ajustable en altura y base universal
 Rebosadero ajustable en altura.
 Regulación del volumen de descarga de agua.
 Incluido adaptador para base roscada.
 Estanqueidad total.
 Alta resistencia a productos químicos y de limpieza.
 Fácil mantenimiento.

*Pull flush valve.
 Compatible with close coupled tanks.
 Pull button adjustable in height.
 Adjustable overflow.
 Adjustable flushing.
 Adapter for threaded base included.
 Water sealing guaranteed.
 High resistance to chemical and cleaning products.
 Easy maintenance.*

Compatibilidad

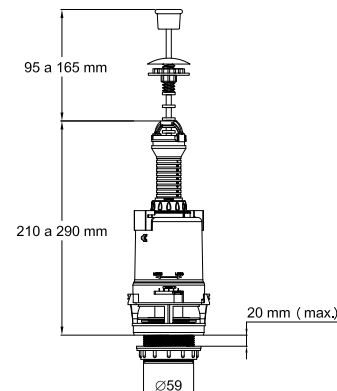
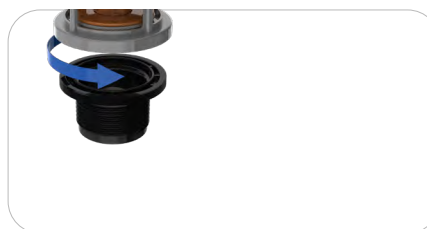

Código Code	Descripción Description	Unid.-Caja Units-Box	Precio Price
70400	Mecanismo / Flush valve Agua	25	9,80 €

Materiales / Materials : ABS / Pp / Hips / Pom

P11

Mecanismo de descarga eléctrico.
Corriente eléctrica 230V.
Adaptable a todas las cisternas de tanque alto.
Alta resistencia a productos químicos y de limpieza.
Máxima estanqueidad garantizada.

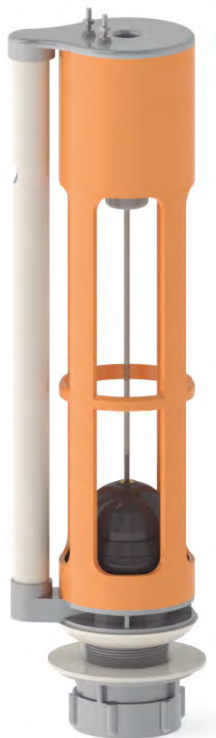

*Electrical valve.
Power supply 230V.
Compatible with high tanks.
High resistance to chemical and cleaning products.
Water sealing guaranteed.*

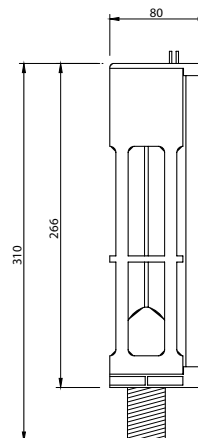

Código <i>Code</i>	Descripción <i>Description</i>	Unid.-Caja <i>Units-Box</i>	Precio <i>Price</i>
60220	Mecanismo / <i>Flush valve</i> P11 230V	25	39,53 €

Materiales / *Materials* : Pp / Pom

Código <i>Code</i>	Descripción <i>Description</i>	Unid.-Caja <i>Units-Box</i>	Precio <i>Price</i>
70301	Doble pulsador / <i>Double push button</i> Niagara +	1	4,00 €

Materiales / *Materials* : ABS / Pom

Código <i>Code</i>	Descripción <i>Description</i>	Unid.-Caja <i>Units-Box</i>	Precio <i>Price</i>
P7011010	Simple pulsador / <i>Simple push button</i> Hydro	1	3,55 €

Materiales / *Materials* : ABS / Pom

Código <i>Code</i>	Descripción <i>Description</i>	Unid.-Caja <i>Units-Box</i>	Precio <i>Price</i>
70401	Tirador / <i>Pull button</i> Aigua	1	3,17 €

Materiales / *Materials* : ABS / Pom

Código <i>Code</i>	Descripción <i>Description</i>	Unid.-Caja <i>Units-Box</i>	Precio <i>Price</i>
70302	Junta cierre / <i>Seal</i> Niagara	1	0,95 €

Materiales / *Materials* : Silicona

Código <i>Code</i>	Descripción <i>Description</i>	Unid.-Caja <i>Units-Box</i>	Precio <i>Price</i>
70315	Junta cierre / <i>Seal</i> Niagara+ , Hydro 2019	1	0,95 €

Materiales / *Materials* : Silicona

Código <i>Code</i>	Descripción <i>Description</i>	Unid.-Caja <i>Units-Box</i>	Precio <i>Price</i>
70402	Junta cierre / <i>Seal</i> Aigua	1	0,96€

Materiales / *Materials* : Silicona



Código <i>Code</i>	Descripción <i>Description</i>	Unid.-Caja <i>Units-Box</i>	Precio <i>Price</i>
P701103	Junta cierre / <i>Seal Hydro</i>	1	0,92 €



Materiales / *Materials* : Silicona

Código <i>Code</i>	Descripción <i>Description</i>	Unid.-Caja <i>Units-Box</i>	Precio <i>Price</i>
90002	Tornillo taza tanque / <i>Screw for tank</i>	1	2,30 €



Materiales / *Materials* : Inox *Stainless steel* / Nylon / Epdm

Código <i>Code</i>	Descripción <i>Description</i>	Unid.-Caja <i>Units-Box</i>	Precio <i>Price</i>
90001	Junta taza tanque / <i>Seal for tank</i>	1	1,70 €



Materiales / *Materials* : Eva foam

Código <i>Code</i>	Descripción <i>Description</i>	Unid.-Caja <i>Units-Box</i>	Precio <i>Price</i>
90003	Conjunto base / <i>Base Set</i>	1	2,30 €



Materiales / *Materials* : ABS / NBR

Código <i>Code</i>	Descripción <i>Description</i>	Unid.-Caja <i>Units-Box</i>	Precio <i>Price</i>
90004	Conjunto adaptador / <i>Adapter Set</i>	1	1,85 €



Materiales / *Materials* : ABS / EPDM

Código <i>Code</i>	Descripción <i>Description</i>	Unid.-Caja <i>Units-Box</i>	Precio <i>Price</i>
61220	Bobina térmica / <i>Thermal reel</i> 230V	1	14,56 €



Materiales / *Materials* : Pom

Código <i>Code</i>	Descripción <i>Description</i>	Unid.-Caja <i>Units-Box</i>	Precio <i>Price</i>
62220	Conjunto térmico / <i>Thermal set 230V</i>	1	18,61 €



Materiales / *Materials* : Pom

Código <i>Code</i>	Descripción <i>Description</i>	Unid.-Caja <i>Units-Box</i>	Precio <i>Price</i>
64010	Boya con varilla / <i>Buoy rod</i>	1	4,05 €



Materiales / *Materials* : Pom

Código <i>Code</i>	Descripción <i>Description</i>	Unid.-Caja <i>Units-Box</i>	Precio <i>Price</i>
65099	Conjunto accesorios / <i>Accessories set</i>	1	9,21 €



Materiales / *Materials* : Pom

Código <i>Code</i>	Descripción <i>Description</i>	Unid.-Caja <i>Units-Box</i>	Precio <i>Price</i>
70019	Casquillo / <i>Tip</i>	1	1,02 €







































































Materiales / *Materials* : Laton Brass

 Sin desmontar el tanque / Without removing the tank

 Desmontar el tanque / Removing the tank

 No compatible / Incompatible





MODELO	Ø TAPA	ACCIONAMIENTO	Niágara+ 70325/35	Niágara+ 70345/55	Niágara 70300	Aqua 70311/12/13
Access	40	Doble pulsador				
América	40	Doble pulsador				
Aquaria	27	Tirador				
Atlanta	27	Tirador/Pl.Elevado				
Atlanta	40	Pulsador enrasado				
Carena	27	Tirador				
Civic	40	Doble pulsador				
Columbia	40	Pulsador enrasado				
Dama retro (Dama)	27	Tirador				
Dama retro (Dama)	27	Pulsador elevado				
Dama retro (Dama)	40	Pulsador enrasado				
Dama retro (Dama)	40	Doble pulsador				
Dama senso	40	Doble pulsador				
Dama senso cpt	40	Doble pulsador				
Dama (Dama-N)	40	Doble pulsador				
Element	40	Doble pulsador				
Frontalis	40	Doble pulsador				
Georgia	40	Pulsador enrasado				
Georgia	40	Doble pulsador				
Giralda	40	Doble pulsador				
Gondola	27	Tirador				
Gondola	27	Pulsador elevado				
Hall	40	Doble pulsador				

Sin desmontar el tanque / Without removing the tank

Desmontar el tanque / Removing the tank

No compatible / Incompatible

MODELO	Ø TAPA	ACCIONAMIENTO	Niágara+ 70325/35	Niágara+ 70345/55	Niágara 70300	Aqua 70311/12/13
Happening	40	Doble pulsador				
Liberty	27	Tirador				
Liberty	27	Pulsador elevado				
Liberty	40	Pulsador enrasado				
Liberty	40	Doble pulsador				
Lucerna/Estudio	18	Tirador				
Meridian	27	Tirador				
Meridian	27	Pulsador elevado				
Meridian	40	Pulsador enrasado				
Meridian	40	Doble pulsador				
Sidney	40	Pulsador enrasado				
Sidney	40	Doble pulsador				
The gap	40	Doble pulsador				
Veranda	40	Doble pulsador				
Verónica	27	Pulsador elevado				
Verónica	40	Pulsador enrasado				
Verónica	40	Doble pulsador				
Victoria	27	Tirador				
Victoria	27	Tir. interrumpible				
Victoria	27	Pulsador elevado				
Victoria	40	Pulsador enrasado				
Victoria	40	Doble pulsador				

-  Sin desmontar el tanque / Without removing the tank
-  Desmontar el tanque / Removing the tank
-  No compatible / Incompatible



MODELO	Ø TAPA	ACCIONAMIENTO	Hydro 70111/12/13	Aigua 70400		
Access	40	Doble pulsador				
América	40	Doble pulsador				
Aquaria	27	Tirador				
Atlanta	27	Tirador/Pl.Elevado				
Atlanta	40	Pulsador enrasado				
Carena	27	Tirador				
Civic	40	Doble pulsador				
Columbia	40	Pulsador enrasado				
Dama retro (Dama)	27	Tirador				
Dama retro (Dama)	27	Pulsador elevado				
Dama retro (Dama)	40	Pulsador enrasado				
Dama retro (Dama)	40	Doble pulsador				
Dama senso	40	Doble pulsador				
Dama senso cpt	40	Doble pulsador				
Dama (Dama-N)	40	Doble pulsador				
Element	40	Doble pulsador				
Frontalis	40	Doble pulsador				
Georgia	40	Pulsador enrasado				
Georgia	40	Doble pulsador				
Giralda	40	Doble pulsador				
Gondola	27	Tirador				
Gondola	27	Pulsador elevado				
Hall	40	Doble pulsador				

 Sin desmontar el tanque / Without removing the tank

 Desmontar el tanque / Removing the tank

 No compatible / Incompatible



MODELO	Ø TAPA	ACCIONAMIENTO	Hydro 70111/12/13	Aigua 70400		
Happening	40	Doble pulsador				
Liberty	27	Tirador				
Liberty	27	Pulsador elevado				
Liberty	40	Pulsador enrasado				
Liberty	40	Doble pulsador				
Lucerna/Estudio	18	Tirador				
Meridian	27	Tirador				
Meridian	27	Pulsador elevado				
Meridian	40	Pulsador enrasado				
Meridian	40	Doble pulsador				
Sidney	40	Pulsador enrasado				
Sidney	40	Doble pulsador				
The gap	40	Doble pulsador				
Veranda	40	Doble pulsador				
Verónica	27	Pulsador elevado				
Verónica	40	Pulsador enrasado				
Verónica	40	Doble pulsador				
Victoria	27	Tirador				
Victoria	27	Tir. interrumpible				
Victoria	27	Pulsador elevado				
Victoria	40	Pulsador enrasado				
Victoria	40	Doble pulsador				

ALTIS



Válvula flotador compacta para alimentación lateral.
Válida para todas las cisternas.
Rango de actuación: 0,5 bar a 12 bar. Resiste picos de presión hasta 16 bar.
Conexión mediante rosca latón 3/8".
Cierre instantáneo mediante sistema servo.
Alta resistencia a productos químicos y de limpieza.
Cuerpo giratorio 180°.
Altura regulable.
Doble vaso.
Alimentación rápida y silenciosa.
Acceso al filtro desde el exterior del tanque.

*Fill valve for lateral inlet.
Valid for all tanks.
Pressure range: 0.5 bar to 12 bar. It resists pressure peaks up to 16 bar.
Connection through brass thread 3/8".
Instant lock through servo system.
High resistance to chemical and cleaning products.
Rotatory body 180°.
Adjustable height.
Double float cup.
Quick and fast water filling.
Access to filter from the exterior of tank.*

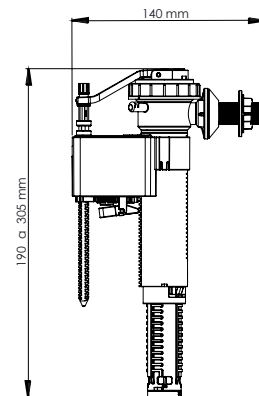

Código Code	Descripción Description	Unid.-Caja Units-Box	Precio Price
80100	Válvula Flotador / Fill valve Altis	15	15,90 €

Materiales / Materials : ABS / Pom / Latón Brass

FORTIS



Válvula flotador compacta para alimentación lateral.
Válida para todas las cisternas.
Rango de actuación: 0,5 bar a 12 bar. Resiste picos de presión hasta 16 bar.
Conexión mediante rosca latón 3/8".
Cierre instantáneo mediante sistema servo.
Alta resistencia a productos químicos y de limpieza.
Cuerpo giratorio 180°.
Altura regulable.
Doble vaso.
Alimentación rápida y silenciosa.
Acceso al filtro desde el exterior del tanque.

*Fill valve for lateral inlet.
Valid for all tanks.
Pressure range: 0.5 bar to 12 bar. It resists pressure peaks up to 16 bar.
Connection through brass thread 3/8".
Instant lock through servo system.
High resistance to chemical and cleaning products.
Rotatory body 180°.
Adjustable height.
Double float cup.
Quick and fast water filling.
Access to filter from the exterior of tank.*

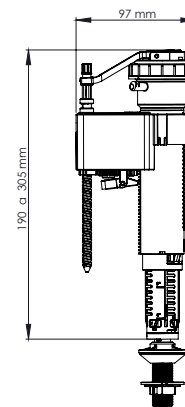

Código Code	Descripción Description	Unid.-Caja Units-Box	Precio Price
80101	Válvula Flotador / Fill valve Fortis	15	15,90 €

Materiales / Materials : ABS / Pom / Latón Brass

FOR-ALL

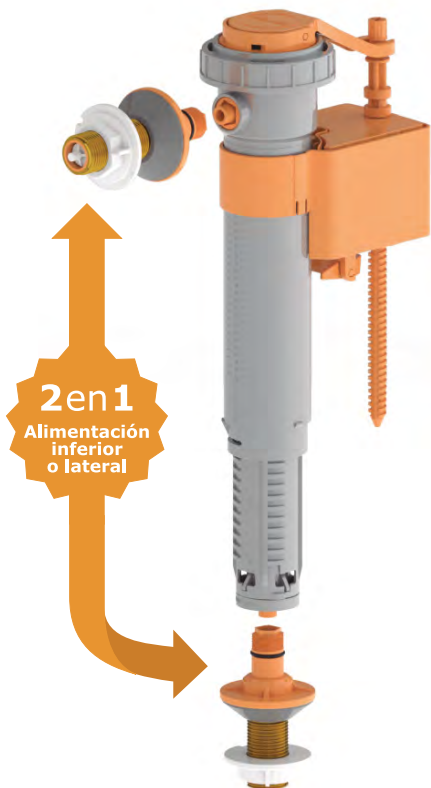

Válvula flotador DUAL compacta para alimentación lateral o inferior.
Válida para todas las cisternas.
Rango de actuación: 0,5 bar a 12 bar. Resiste picos de presión hasta 16 bar.
Conexión mediante rosca latón 3/8".
Cierre instantáneo mediante sistema servo.
Alta resistencia a productos químicos y de limpieza.
Cuerpo giratorio 180°.
Altura regulable.
Doble vaso.
Alimentación rápida y silenciosa.
Acceso al filtro desde el exterior del tanque.

*DUAL fill valve for lateral or bottom inlet.
Valid for all tanks.
Pressure range: 0.5 bar to 12 bar. It resists pressure peaks up to 16 bar.
Connection through brass thread 3/8".
Instant lock through servo system.
High resistance to chemical and cleaning products.
Rotatory body 180°.
Adjustable height.
Double float cup.
Quick and fast water filling.
Access to filter from the exterior of tank.*

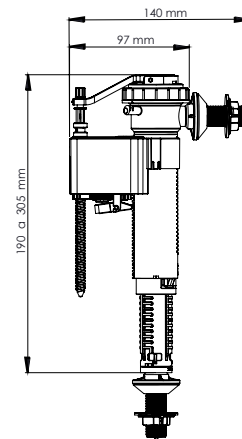

Código Code	Descripción Description	Unid.-Caja Units-Box	Precio Price
80100	Válvula Flotador / Fill valve For-All	15	18,75 €

Materiales / Materials : ABS / Pom / Latón Brass

Código <i>Code</i>	Descripción <i>Description</i>	Unid.-Caja <i>Units-Box</i>	Precio <i>Price</i>
80192	Junta obturación / <i>Sealing gasket</i>	1	1,83 €

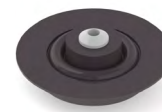

Materiales / *Materials* : Pom / EPDM

Código <i>Code</i>	Descripción <i>Description</i>	Unid.-Caja <i>Units-Box</i>	Precio <i>Price</i>
80194	Conexión toma agua 3/8" / <i>Water inlet connection 3/8"</i>	1	2,50 €



Materiales / *Materials* : ABS / Pom / Latón Brass

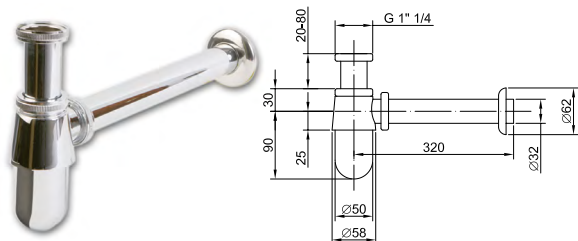

Código-Code	Descripción-Description	Ud/Caja-Units/box	Precio-Price
50070	1"1/4 ø32mm x 250mm	20	19,11 €

Sifón botella cromado

Chromed plated "bottle-trap"

Materiales / Materials : Latón Brass

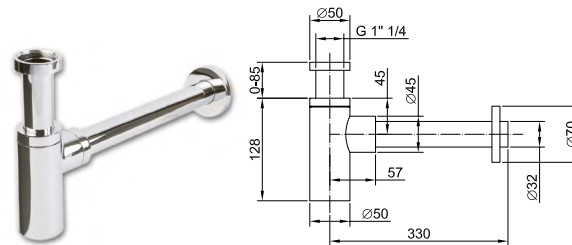

Código-Code	Descripción-Description	Ud/Caja-Units/box	Precio-Price
50080	1"1/4 ø32mm	20	65,52 €

Sifón botella cromado corte minimalista para lavabo

Minim-all line washbasin chromed-plated "bottle-trap"

Materiales / Materials : Latón Brass

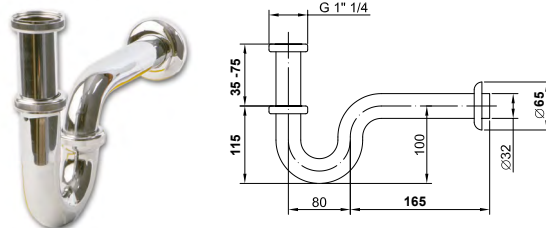

Código-Code	Descripción-Description	Ud/Caja-Units/box	Precio-Price
50060	1"1/4 ø32mm	20	16,38 €

Sifón articulado cromado

Chromed plated "tubular-trap"

Materiales / Materials : Latón Brass

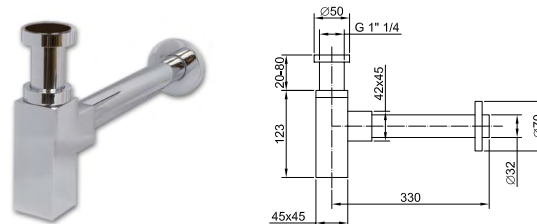

Código-Code	Descripción-Description	Ud/Caja-Units/box	Precio-Price
50090	1"1/4 ø32mm	20	73,27 €

Sifón botella cromado corte minimalista para lavabo

Minim-all line washbasin chromed-plated "bottle-trap"

Materiales / Materials : Latón Brass

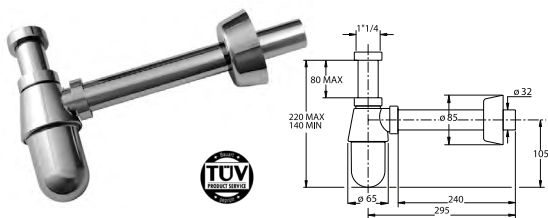

Código-Code	Descripción-Description	Ud/Caja-Units/box	Precio-Price
B0570T25K7	1"1/4 ø 32 x 250 mm	25	14,96 €
B0570T23K7	1"1/4 ø 40 x 230 mm	25	18,73 €

Sifón botella cromado

Chromed plated "bottle-trap"

Materiales / Materials : ABS + Latón Brass

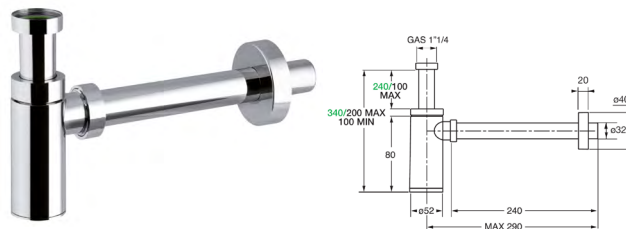

Código-Code	Descripción-Description	Ud/Caja-Units/box	Precio-Price
B0595PR25K7	1"1/4 ø 32 x 250 mm	25	35,80 €

Sifón botella cromado corte minimalista para lavabo

Minim-all line washbasin chromed-plated "bottle-trap"

Materiales / Materials : ABS + Latón Brass

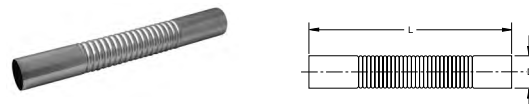
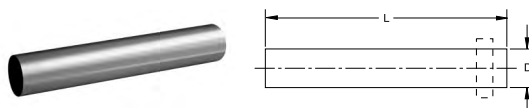

Código-Code	Descripción-Description	Ud/Caja-Units/box	Precio-Price
50120	∅ 32 X 30 cm.	50	6,19 €

Tubo alargado

Flanged outlet pipe

Materiales / Materials : Latón Brass

Código-Code	Descripción-Description	Ud/Caja-Units/box	Precio-Price
B0632FX30B7	∅ 32 X 30 cm.	50	11,30 €

Tubo alargado flexible

Flexible pipe

Materiales / Materials : Latón Brass

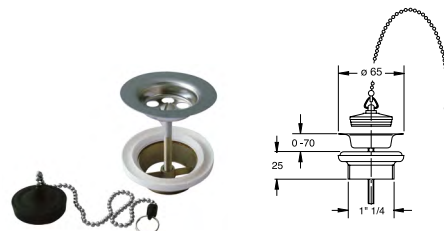
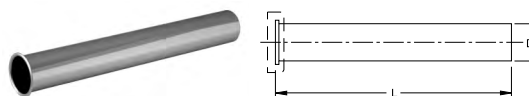

Código-Code	Descripción-Description	Ud/Caja-Units/box	Precio-Price
B0632CC25B7 *	∅ 32 X 25 cm.	50	5,30 €
50100	∅ 32 X 30 cm.	50	5,46 €
50110	∅ 32 X 50 cm.	54	8,73 €

Tubo alargado con solapa

Flanged pipe

Materiales / Materials : Latón Brass

* ABS

Código-Code	Descripción-Description	Ud/Caja-Units/box	Precio-Price
50050	Conexión rosca-Spiral connection 1" 1/4	50	10,12 €

Válvula con rejilla y tapón cromado con cadenilla

Chain basin waste

Materiales / Materials : Latón Brass

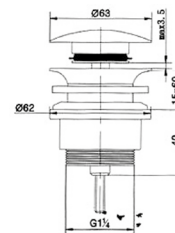
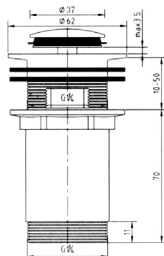

Código-Code	Descripción-Description	Ud/Caja-Units/box	Precio-Price	Código-Code	Descripción-Description	Ud/Caja-Units/box	Precio-Price
B08330T37S7	Conexión rosca-Spiral connection 1"1/4	24	17,26 €	B08340T66S7	Conexión rosca-Spiral connection 1"1/4	30	22,43 €

Válvula cromada universal click-clack cuello largo
Universal chromed-plated valve clic-clack long neck
Materiales / Materials : Latón Brass

Válvula cromada universal click-clack tornillo
Universal chromed-plated valve clic-clack mini with screw
Materiales / Materials : Latón Brass Latón Brass

RECAMBIOS SPARE PARTS



Código-Code	Descripción-Description	Ud/Caja-Units/box	Precio-Price
R5010002	B08330T37S7	20	3,08 €
R5010003	B08340T66S7	20	3,08 €
R5010004	B08340T37S7	20	3,08 €

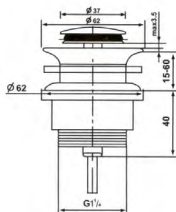

Código-Code	Descripción-Description	Ud/Caja-Units/box	Precio-Price
B08340T37S7	Conexión rosca-Spiral connection 1"1/4	30	17,26 €

Válvula cromada universal click-clack tornillo mini
Universal chromed-plated valve clic-clack with screw
Materiales / Materials : Latón Brass

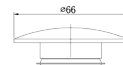

Código-Code	Descripción-Description	Ud/Caja-Units/box	Precio-Price
R5010001	B08340T66S7	20	5,25 €



Código-Code	Descripción-Description	Ud/Caja-Units/box	Precio-Price
R5010005	Junta cierre-Silicon seal	20	1,20 €

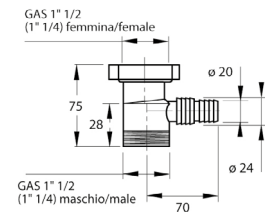
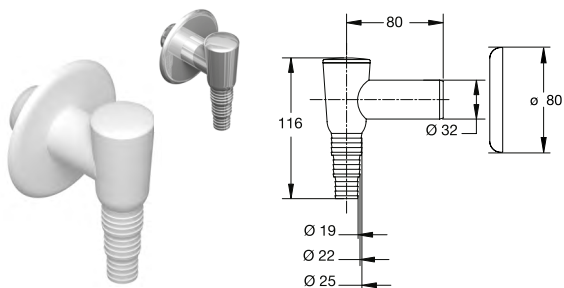

Código-Code	Descripción-Description	Ud/Caja-Units/box	Precio-Price	Código-Code	Descripción-Description	Ud/Caja-Units/box	Precio-Price
B3530GZ32B0	Ø 32 mm, color blanco- <i>white colour</i>	50	7,64 €	B1825AR64B0	Conexión 1"1/2 x 1"1/2	50	3,22 €
B3530CR32K7	Ø 32 mm, color cromado- <i>chromed-plated</i>	50	12,60 €		Conexión lavavajillas bajo fregadera 1"1/2		

Sifón de válvula "Styling" para montaje externo a la pared

"Styling" external valve trap

Materiales / *Materials* : ABS

Conexión lavavajillas bajo fregadera 1"1/2

Underwaste washing machine connection 1"1/2

Materiales / *Materials* : PP

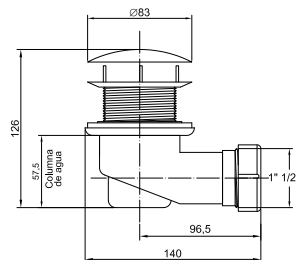
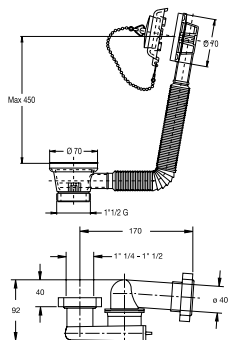

Código-Code	Descripción-Description	Ud/Caja-Units/box	Precio-Price	Código-Code	Descripción-Description	Ud/Caja-Units/box	Precio-Price
B4148EX64B0	Desagüe bañera-Bath tub's waste	20	18,27 €	B5890CR80B2	Ø 80 mm x 1"1/2	25	20,02 €

"Extensina" desagüe bañera con sifon 1"1/2 x 40

"Extensina" waste for bath tubs 1"1/2 x 40 with complete trap

Materiales / Materials : PP / ABS

Válvula inspeccionable para plato ducha Ø 80

Trap for shower plates hole Ø 80

Materiales / Materials : PP

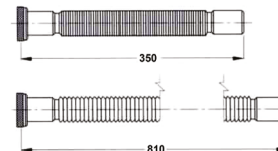
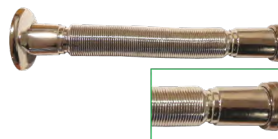
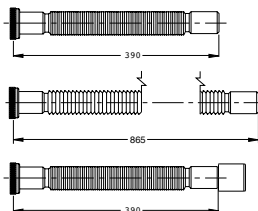

Código-Code	Descripción-Description	Ud/Caja-Units/box	Precio-Price
B9334OT54B0	1"1/4 x ø 32-40 mm	100	4,49 €
B9345OT64B0	1"1/2 x ø 40-50 mm	70	4,49 €

"Magikone" tubo de conexión flexible extensible

"Magikone" flexible & extensible pipe connection

Materiales / Materials : PP

Código-Code	Descripción-Description	Ud/Caja-Units/box	Precio-Price
B9332RS54B7	1"1/4 x ø 32 mm tuerca latón cromado-brass nut chromium-plated	30	12,30 €
B9340RS64B7	1"1/2 x ø 40 mm tuerca latón cromado-brass nut chromium-plated	30	12,30 €

"Magikone" tubo de conexión flexible extensible cromado

"Magikone" flexible & extensible pipe connection chromed plated

Materiales / Materials : PP

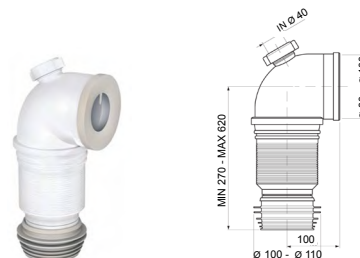
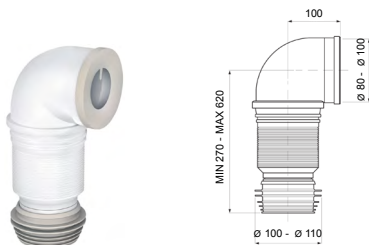

Código-Code	Descripción-Description	Ud/Caja-Units/box	Precio-Price
B8820PP10C0 *	Ø 100-110 mm	16	21,48 €

"Bigmagik" manguito flexible extensible WC acodado
"Bigmagik" flexible & extensible pipe conection WC 90° bended
Materiales / Materials : PP / Tpe

Código-Code	Descripción-Description	Ud/Caja-Units/box	Precio-Price
B8821PP10C0 *	Ø 100-110 mm	20	21,85 €

"Bigmagik" manguito flexible extensible WC acodado
"Bigmagik" flexible & extensible pipe conection WC 90° bended
Materiales / Materials : PP / Tpe

bigmagik

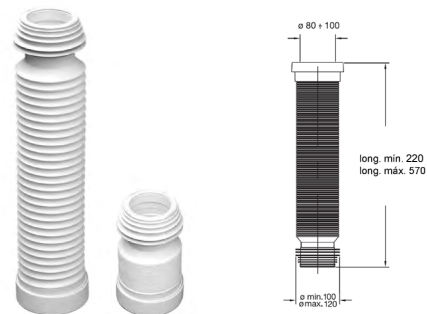

Código-Code	Descripción-Description	Ud/Caja-Units/box	Precio-Price
B8250EX55B0	Ø 100-110 mm	30	20,13 €

"Bigmagik" manguito flexible extensible WC
"Bigmagik" flexible & extensible pipe conection WC
Materiales / Materials : PP / Tpe

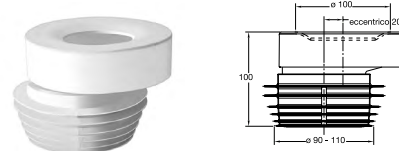
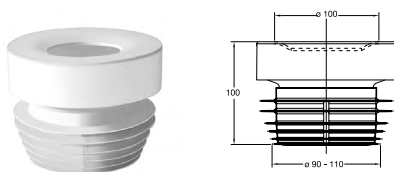

Código-Code	Descripción-Description	Ud/Caja-Units/box	Precio-Price	Código-Code	Descripción-Description	Ud/Caja-Units/box	Precio-Price
B8424BR10B0	∅ 100-110 mm	20	8,82 €	B8426BR10B0	∅ 100-110 mm excéntrico-eccentric 20 mm	20	8,82 €
B8424BR90B0	∅ 90-100 mm	20	8,82 €	B8426BR90B0	∅ 90-100 mm excéntrico-eccentric 20 mm	20	8,82 €

"Bi Power" manguito WC

"Bi Power" pipe connection WC

Materiales / Materials : PP / Tpe

"Bi Power" manguito WC

"Bi Power" pipe connection WC

Materiales / Materials : PP / Tpe

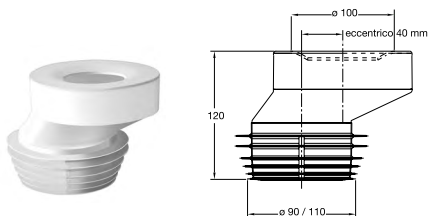

Código-Code	Descripción-Description	Ud/Caja-Units/box	Precio-Price
B8428BR10B0	∅ 100-110 mm excéntrico-eccentric 40 mm	20	8,82 €
B8428BR90B0	∅ 90-100 mm excéntrico-eccentric 40 mm	20	8,82 €

"Bi Power" manguito WC

"Bi Power" pipe connection WC

Materiales / Materials : PP / Tpe

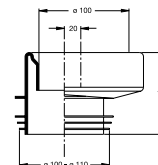
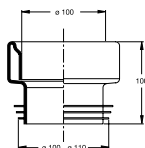

Código-Code	Descripción-Description	Ud/Caja-Units/box	Precio-Price	Código-Code	Descripción-Description	Ud/Caja-Units/box	Precio-Price
B8416PV10C0	∅ 100-110 mm	25	3,46 €	B8418PV10C0	∅ 100-110 mm excéntrico-eccentric 20 mm	25	3,46 €

Manguito WC

Pipe connection WC

Materiales / Materials : PVC

Manguito WC

Pipe connection WC

Materiales / Materials : PVC

Pedidos.-

Los pedidos deberán ser remitidos por escrito, y firmados por el comprador, a Prhie Components, S.L. Ello supone la aceptación por el cliente de todas las condiciones generales de venta. No se procesarán pedidos inferiores a 30,00 euros.

Precios.-

Los precios reflejados en nuestra tarifa son los recomendados de venta al público y están expresados en Euros. Los precios no incluyen IVA. Podrán ser modificados en cualquier momento sin previo aviso.

Plazos de entrega.-

Los plazos de entrega establecidos se entienden, en todo caso, sin compromiso y deben considerarse solamente a título orientativo; no aceptando, en consecuencia, reclamación alguna por el retraso que pudiera presentarse en los envíos.

Forma de entrega.-

Queda reservado el derecho de efectuar entregas parciales de los pedidos aceptados, sin el compromiso de entregarlos completos de una sola vez.

El transporte es por cuenta de Prhie, salvo indicación en contra del comprador, y siempre que el valor neto de la mercancía supere el mínimo de (350,00 € Península) (500,00 € Islas Baleares) (700,00 € Islas Canarias) (700,00 € Andorra), impuestos no incluidos. Para otros mercados de exportación por favor contacte con el departamento de export.

Embalajes.-

La mercancía se expedirá embalada en la forma establecida por el Prhie y su coste será a cargo del comprador cuando se requiera un embalaje especial.

Anulaciones.-

Cualquier anulación deberá ser comunicada por escrito y no se aceptarán en los siguientes casos:

- Cuando la expedición del mismo haya sido realizada.
- Cuando se trate de productos especiales no incluidos en tarifa.
- Prhie se reserva el derecho de anular los pedidos pendientes de entrega si el comprador ha incumplido, total o parcialmente, anteriores acuerdos.

Garantía.-

El período de garantía es de 2 años, siempre y cuando las mercancías hayan sido almacenadas, mantenidas y utilizadas cuidadosamente por el comprador.

El material será repuesto siempre y cuando haya sido previamente inspeccionado por los técnicos de Prhie, su instalación se haya efectuado de acuerdo con la normativa vigente y esté probado que es defectuoso.

Prhie no se hace responsable de los daños que directa o indirectamente pudieran ocasionar los defectos de sus productos, si estos han sido manipulados o en su instalación se han utilizados siliconas o sellantes industriales cuyos componentes deterioren el producto.

La garantía solo ampara los defectos de fabricación y los costes de reposición del producto.

Queda excluida de esta garantía cualquier otra reclamación que por defecto del producto pudiera derivarse.

Reclamaciones.-

La venta se considera en firme en el momento de la recepción de la mercancía por parte del cliente. Se establece un plazo de 10 días para atender cualquier reclamación derivada de la calidad. Transcurrido este plazo, la mercancía quedará sujeta a la garantía general.

Expediciones.-

La mercancía viajará siempre por cuenta y riesgo del comprador.

Devoluciones.-

No será admitida ninguna devolución sin previa autorización por parte de Prhie. Del importe de la devolución será deducido un 10% en concepto de costes de recepción y revisión. En cualquier caso la mercancía deberá ser remitida a portes pagados y en la fecha acordada previamente con Prhie.

Condiciones de pago.-

El pago de las mercancías será efectuado en las condiciones pactadas con el comprador y en los plazos estipulados con el mismo. Prhie se reserva el derecho de suspender las entregas parciales o totales de un pedido si el comprador incumpliese cualquiera de las condiciones acordadas con el primero.

Reserva de modificación.-

Prhie se reserva el derecho de modificar sin previo aviso, el diseño y medidas de todos nuestros fabricados.

Reserva de dominio.-

Prhie mantendrá la propiedad de las mercancías suministradas en tanto el pago de las mismas no haya sido recibido. El comprador tomará todas las medidas necesarias para la protección de los derechos de propiedad de Prhie.

Impuestos.-

Serán aplicados en factura, sobre los precios de la tarifa vigente, los impuestos que procedan de acuerdo con la legislación vigente. Cualquier otro gravamen que pudiera decretarse será asimismo cargado.

Jurisdicción.-

Ambas partes, comprador y vendedor, se someten expresamente a la jurisdicción de los tribunales y Juzgados de Barcelona en caso de litigio.

Orders.-

The orders will be send in writing, and signed by the buyer, to Prhie Components, S.L. It suppose the acceptance by the customer of all the sales conditions. Orders less than 30 euros, will not be processed.

Prices.-

*The prices reflected in our catalogue are the retail price, expressed in Euro.
The prices can be modified without previous notification.*

Delivery date.-

Established delivery dates, are understood, in all the cases, without any obligation and must be considered only as guidance; no accepted, in consequence, any claim related to delivery delay.

Delivery method.-

*Accepted orders could be delivered in different shipments.
PRHIE COMPONENTS S.L. will bear the logistic fees in those orders which the net invoice value is over 350€ for Iberian Peninsula, 700€ for Canary Islands, 500€ for Balearic Islands, 700€ for Andorra and 700€ for Portugal. For other markets please contact with export department at export@prhie.com to get further information.*

Packaging.-

Goods will be send according the packaging way accorded by the supplier, the cost will be charged to the buyer when it requires an special packaging.

Cancellations.-

Any cancellation will be send by writing, will not be accepted in the following cases:

- When the expedition have been sendend.*
- Special goods not included in the price list.*
- The right of cancell pending deliveries can be executed by Prhie if the buyer have broken, totally or partially previous deals.*

Guarantee.-

*Guarantee period is for 2 years, as long as the goods has been stored and carefully used by the buyer.
The material will be stocked up as long as have been previously inspected for our technicians, have been installed according currently regulation and proved that it is defective.
Prhie is not responsible of the damages that directly or indirectly could caused product's defective, if they have been handled or in their installation have been used industrials silicones or seals which components can damage the product.
Guarantee just protect manufactures's defect and the product replacement cost.
Is excluded from this guarantee any other claim that could derive from defective's product.*

Claims.-

The sale will be considered in firm when the customer recives the goods. Claims regarding the product's quality will be accepted during first 10 days, after goods delivery.

Expeditions.-

Goods will always travel at the expense and risk of the client.

Goods returns.-

Any return will not be accepted without previous authorization.

10% of returns value will be deduced concerning reception and checking costs. In any case, goods will be sended free of charge and in the date accorded with us.

Payment conditions.-

Goods payments will be maked according conditions agreed with the buyer and during the period accorded.

The right of cancell partial or full deliveries is reserved if the buyer does not fullfill any of the conditions accorded with Prhie Components, S.L.

Modification reserve.-

The right of modify product's mesurements or design is reserved by Prhie Components, S.L.

Reservation of Ownership.-

Prhie will keep the goods in property till receive the payment. The buyer will do everything necessary to keep Prhie's property rights protection.

Taxes.-

Will be applied in the invoice, according our price list, taxes will be applied according currently regulation. Any other tax detected will be charged.

Jurisdiction.-

Both parts, buyer and seller, are subject by choice, to the jurisdiction and Barcelona's court's (Spain) in case of lawsuit.

***Marca titular de Roca Sanitario, S.A.**
Marca no relacionada con PRHIE COMPONENTS, S.L.

**Trademark of Roca Sanitario, S.A.*
Trademark not related with PRHIE COMPONENTS, S.L.



Prhie Components, S.L.

Pol. Ind. Llinars Park
Agricultura, 6-8
08450 Llinars del Valles
(Barcelona) España

t: (+34) 938413604
f: (+34) 938411081

w: www.prhie.com
e: prhie@prhie.com